

BOSS

GARAGE DOOR OPERATORS

ROLLER DOOR OPERATOR RD9

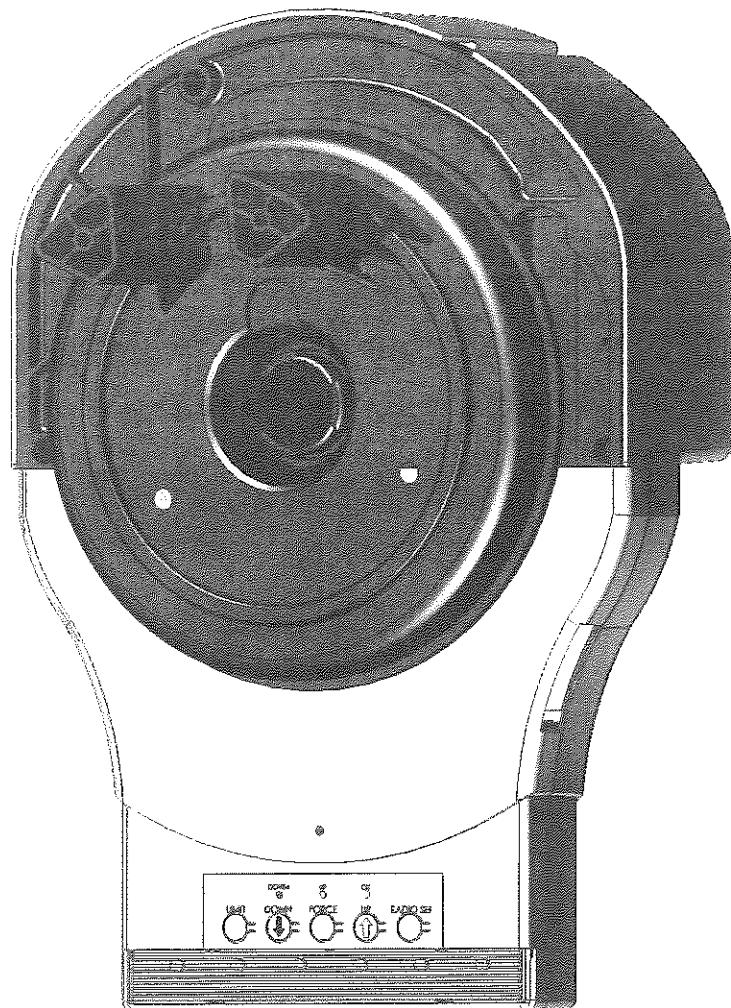

Owner's Manual

READ THIS MANUAL CAREFULLY BEFORE BEGINNING INSTALLATION

Installer: Permanently attach manual to the wall.

RD9 SPECIFICATION

Electrical Rating

Input	AC 220V 50/60Hz
Max. Current	8A
Power	100W
Standby Power	2W

Motor

Type	DC 24V
Max. Capacity	800N

Recommended Lifting Forces

Max. Lifting Force	25kg
Rated Lifting Force	15kg

Door Type

Max. Door Size	12m ²
Max. Door Weight	100kg
Max. Door Height	3.5m
Door Travel Limits	3.2 turns of door drum approx.

Courtesy Light

Light Source	6 x Ultra Bright LEDs
Lighting Time	2.5 minutes

Transmitter

Frequency	303MHz
Operation Range	50m (open field)
Coding Type	Fixed-code
Battery	12V (A23 Alkaline) x 1

Features

Soft opening and closing
Safety reverse on closing and stop on opening
Digital interface for RH/LH setting, force adjustment, etc.
Separable control panel for ease of access*

Miscellaneous

Operating Temperature	-20 C ~ +50 C
Dimension (mm)	400 L x 280 W x 214H
Weight	5.4kg approx.

TABLE OF CONTENTS

Pre-Installation Notes	3
Important Notices	4
Installation Instructions	5
Connectors	5
Setting Direction of Operation	6
Setting UP-Limit	7
Setting DOWN-Limit	8
Sensitivity Auto-Learning	9
Manual Sensitivity Adjustment (For Installers Only)	10
Programming Transmitter	11
Setting Auto-Closing Timer	12
Trouble-Shooting	13
Parts Breakdown	14
Warranty	15

PRE-INSTALLATION NOTES

The operator may be fitted to either the RIGHT or LEFT hand side of the roller door.

Check that there is sufficient side clearance to fit the operator unit as below listed:

Door Type	Minimum side clearance
"A" Series (25mm deep tracks)	100mm
"AA" Series (50mm deep tracks)	125mm
All doors with Windlok Tracks subject to Drum Position	150mm

Ensure there is a properly earthed mains supply socket adjacent to where the operator is to be fitted.

If the operator is being fitted at the same time as the new door installation, read these instructions in conjunction with the door installation instructions.

If the operator is being retro-fitted, make sure the door operates smoothly and is properly balanced.

N.B.: SPECIAL CARE SHOULD BE TAKEN IF RE-TENSIONING OF THE DOOR IS REQUIRED.

At no stage should you loosen both "U" bolts if door is under tension.

IMPORTANT NOTICES

IMPORTANT : PLEASE READ THESE INSTRUCTIONS CAREFULLY PRIOR TO COMMENCING THE INSTALLATION OF THE OPERATOR UNIT.

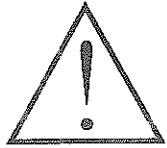

CAUTION

This Automatic Opener has been designed to provide years of trouble-free use. The opener will perform efficiently only if it is installed and operated properly.

READ THESE IMPORTANT SAFETY RULES FIRST

Keep the garage door balanced. Sticking or binding doors must be repaired. Garage door, door springs, brackets and their hardware are under extreme tension and can cause serious personal injury. **Do not attempt adjustment.** Call for professional garage door service .

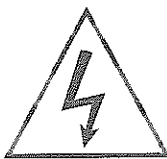

DANGER

Do not wear rings, watches or loose clothing while installing or servicing a garage door operator.

Installation and wiring must be in compliance with your local building and electrical codes. Connect the power cord only to properly earthed mains.

The **safety reverse system** test is very important. Your garage door must reverse when obstructed on closing. Failure to properly adjust the operator may result in serious personal injury from a closing garage door. Repeat the test once a month and make any needed adjustments. (See Sensitivity adjustment).

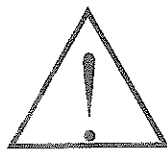

CAUTION

This unit should not be installed in a damp or wet space.

Push the Emergency Release handle to disengage the motor drive **ONLY** when the drive is switched OFF and, if possible, when the door is fully closed.

Do not use the sensitivity adjustments to compensate for a binding or sticking garage door. Excessive sensitivity will interfere with the proper operation of the Safety Reverse System or damage the garage door.

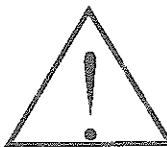

CAUTION

Disengage all existing garage door locks to avoid damage to garage door.

Install any additional Push Buttons in a location where the garage door is visible, but out of the reach of children. Do not allow children to operate push button (s) or remote control (s). Serious personal injury from a closing garage door may result from misuse of the operator.

CAUTION: Activate operator only when the door is in full view, free of obstructions and the operator is properly adjusted. No one should enter or leave the garage while the door is in motion. Do not allow children to play near the door.

Disconnect electric power to the garage door operator before making repairs or removing covers.

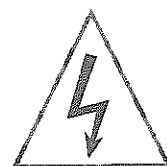

DANGER

IMPORTANT: Fix the caution label supplied to the rear of the garage door as a reminder of safe operating procedures.

NOTE: 1. When you disengage the unit, please move the door gently.
2. Direction of operation (L/R) must be set correctly before operation.

IF THERE IS ANY PROBLEM PLEASE CONTACT YOUR LOCAL SUPPLIER OF THIS OPERATOR

INSTALLATION INSTRUCTIONS

1. Fit anti-coning collar TIGHT TO SHAFT against drum at opposite end of curtain to the motor using nuts and bolts supplied in kit as shown in Fig.1.
2. Roll up door with at least 100mm of curtain hanging down in the tracks.
3. Ensure that the U-bolt on the end of the door opposite the end to which the opener is to be fitted is tightened securely. This U-bolt holds all the spring tension on the door once the other U-bolt is released.
4. Slide drive unit onto shaft as shown in Fig.2. Ensure the drive lugs engage fully with the narrowest spoke on drum wheel.
5. For ease of installation, the sun gear can be disengaged for free rotation by pushing the Emergency Release handle upwards. To re-engage and lock the sun gear, pull the handle downwards.

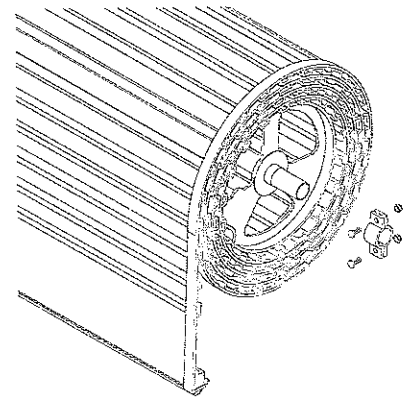

Fig.1

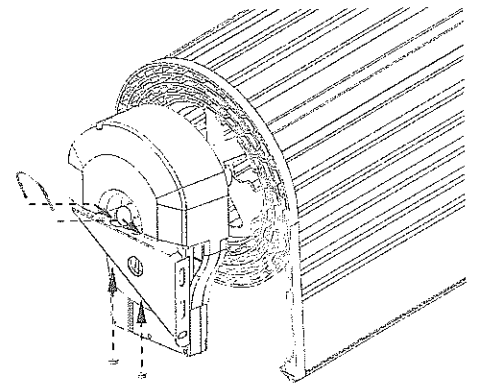
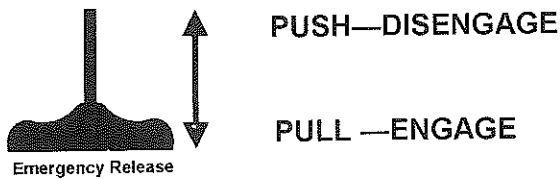
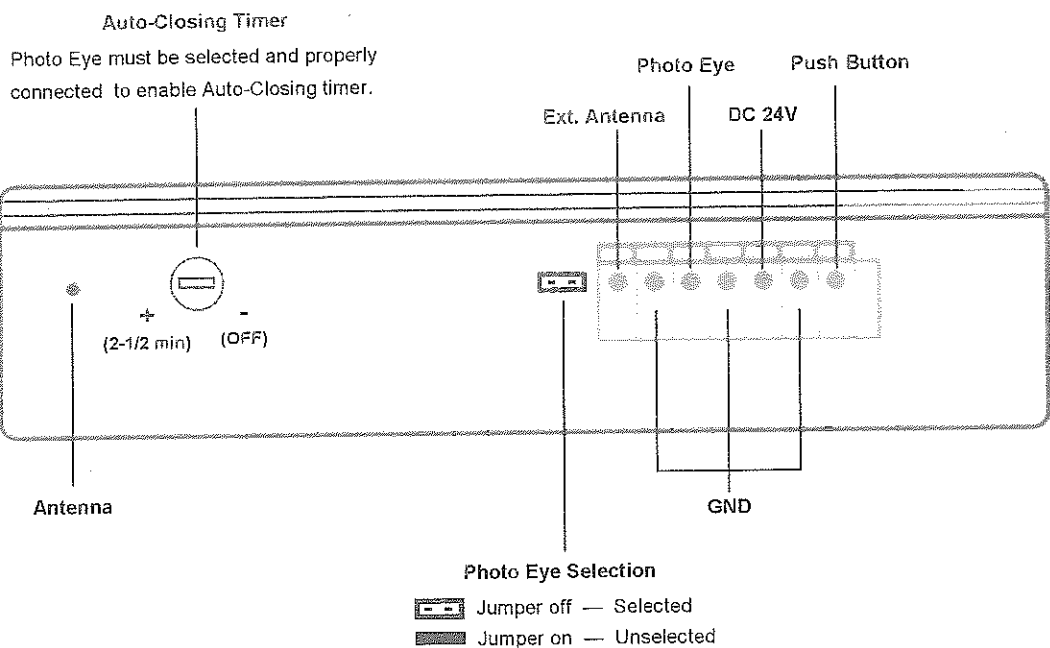

Fig.2

Caution : Opener must be ENGAGED before proceeding further installation.



CONNECTORS



SETTING DIRECTION OF OPERATION

For using the opener the first time, it is necessary to set the direction of operation.

1. Connect power supply, both "UP" and "DOWN" indicators are on.

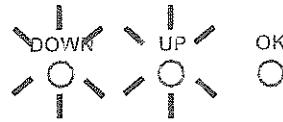

2. Initialize the operational direction by pressing "UP" or "DOWN" button for the correct direction setting according to the illustrations below. The corresponding indicator is on upon key input.

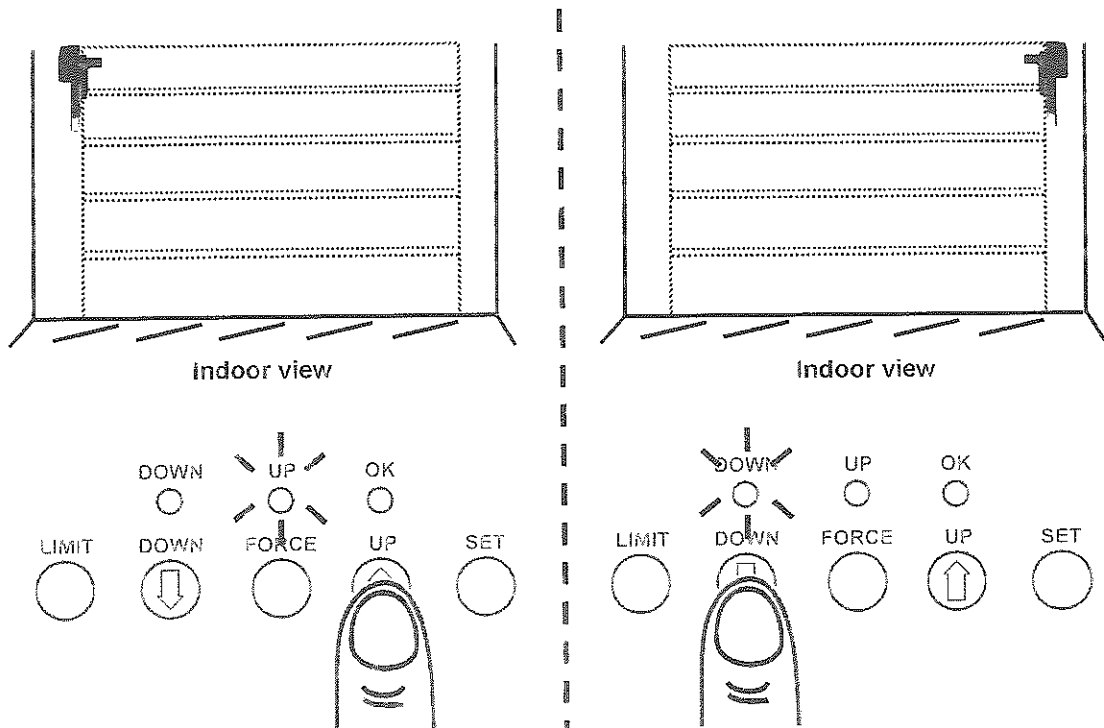

3. Press "SET" button to confirm setting. The "OK" indicator is on with 2 beeps.

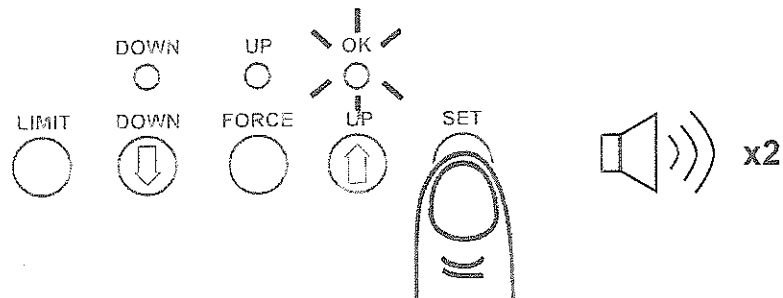

Caution : Make sure the drive unit is set for the correct side of installation!

To reset installation direction, press and hold "LIMIT" button until both "UP" and "DOWN" indicators are ON, repeat steps 2 and 3 to set the appropriate direction.

SETTING UP LIMIT

1. Press "LIMIT" button once to enter limit-setting mode. "UP" indicator is on.

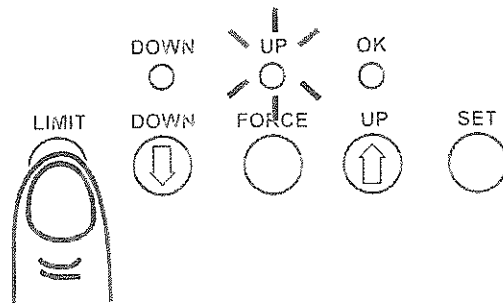

2. Press & hold the "UP" button. Door travels up. When the door reaches the desired up limit position, release the "UP" button. Door stops.

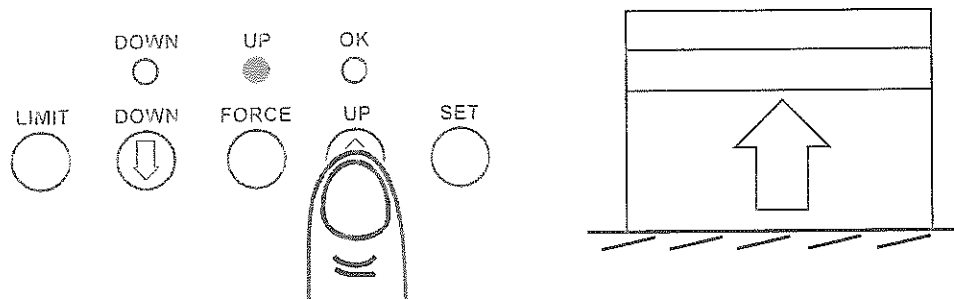

3. During limit-setting mode, press "UP" or "DOWN" to fine-tune to desired UP limit position.

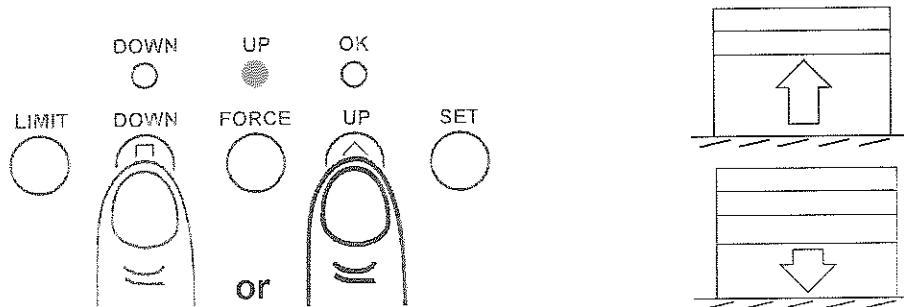

4. When the door is at the desired UP limit position, press "LIMIT" button once, "OK" indicator flashes and goes out. UP limit is set.

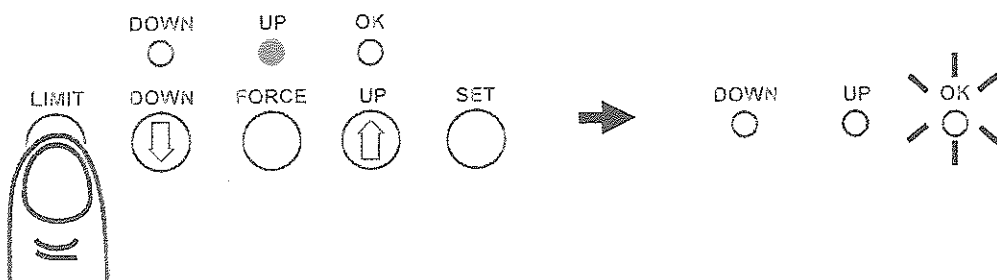

SETTING DOWN LIMIT

1. Press "LIMIT" button twice to enter DOWN-limit setting. "DOWN" indicator is on.

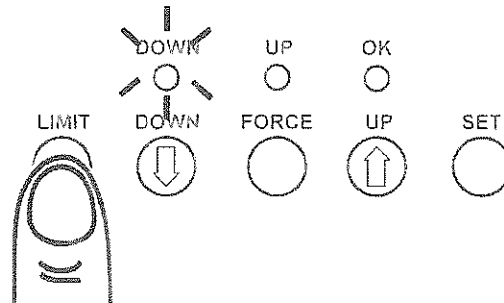

2. Press & hold the "DOWN" button, door travels down. When the door reaches the desired down limit position, release the "DOWN" button. Door stops.

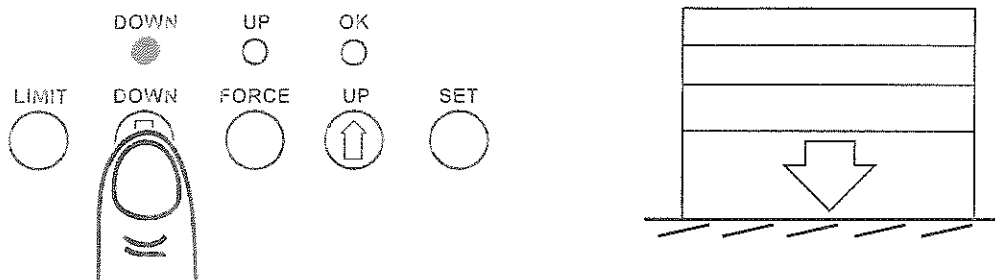

3. During limit-setting mode, press "UP" or "DOWN" to fine-tune to desired down limit position.

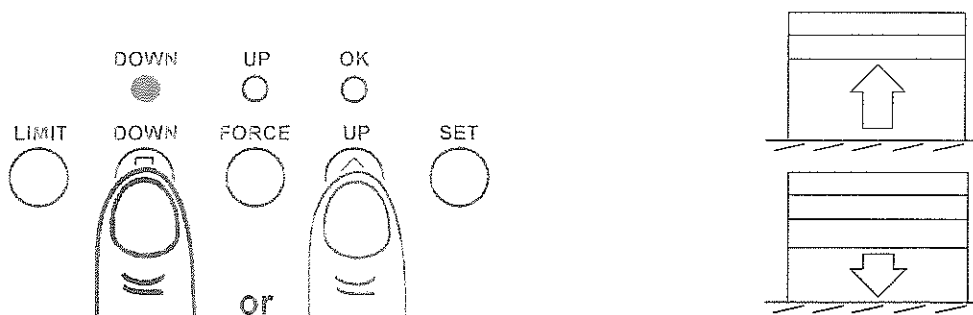

4. When the door is at the desired DOWN limit position, press "LIMIT" button once, "OK" indicator flashes twice and both "UP" and "DOWN" indicators is on. DOWN limit is set and the opener is ready for Sensitivity Auto-Learning.

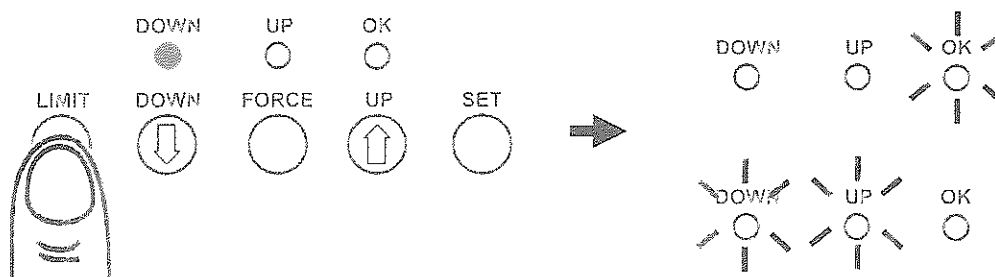

SENSITIVITY AUTO-LEARNING

Following limit-setting, the unit is now ready to learn the sensitivity for door travel automatically. Proceed with the following steps to complete installation.

1. With both "UP" and "DOWN" indicators are on after limit-setting, press the "FORCE" button once to enter Sensitivity Auto-Learning mode.

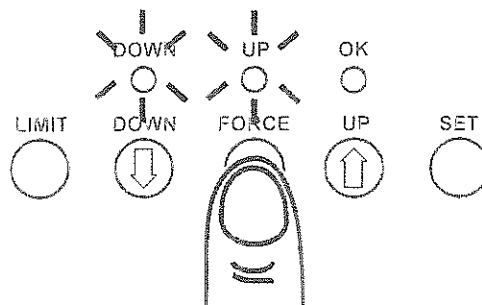

2. The door will travel and stop at UP limit for 2 seconds.

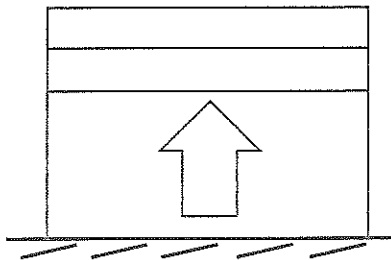

3. Door will then travel down and stop at down limit. The opener will beep 3 times, sensitivity is learnt automatically.

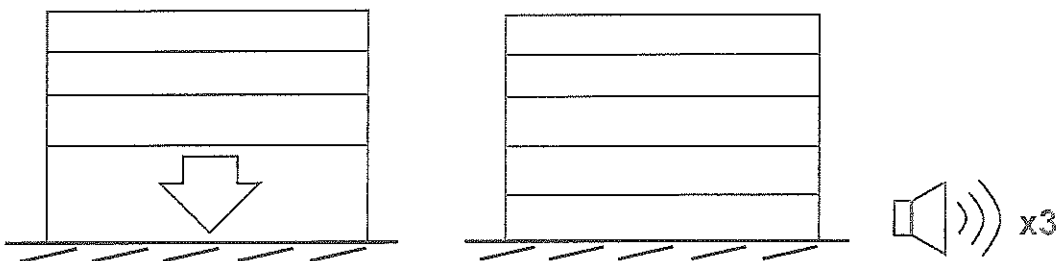

MANUAL SENSITIVITY ADJUSTMENT (FOR INSTALLER ONLY)

To adjust UP Force

1. Press "FORCE" button, "UP" LED is on. You are now in "UP Force Setting" mode.
2. To increase or decrease UP force by pressing "UP" or "DOWN" button once at a time, a beep sound indicates an increase or decrease for one increment. The UP Force is default at level 5.
3. To complete "UP Force" setting, press "FORCE" button. "UP" LED goes off and "OK" LED flashes once with 2 beeps. "UP Force" setting is completed.

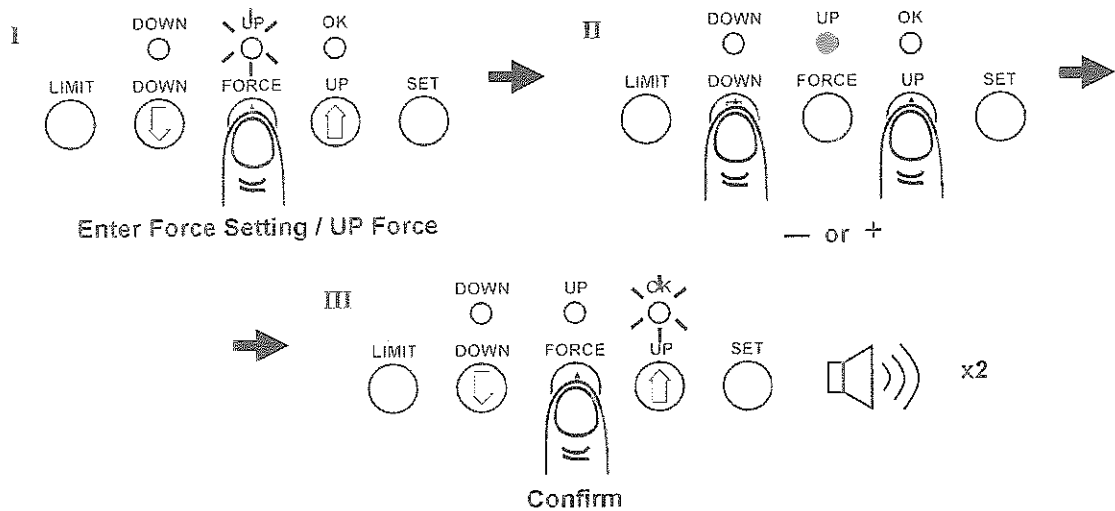

To adjust DOWN Force

1. To adjust DOWN force, press "FORCE" button once, "UP" LED is on, then press "FORCE" button again within 5 seconds, "DOWN" LED is on, you are now in "DOWN Force Setting" mode.
2. To increase or decrease DOWN force by pressing "UP" or "DOWN" button once at a time, a beep sound indicates an increase or decrease for one increment. The DOWN Force is default at level 1.
3. To complete "DOWN Force" setting, press "FORCE" button. "DOWN" LED goes off and "OK" LED flashes once with 2 beeps. "DOWN Force" setting is completed.

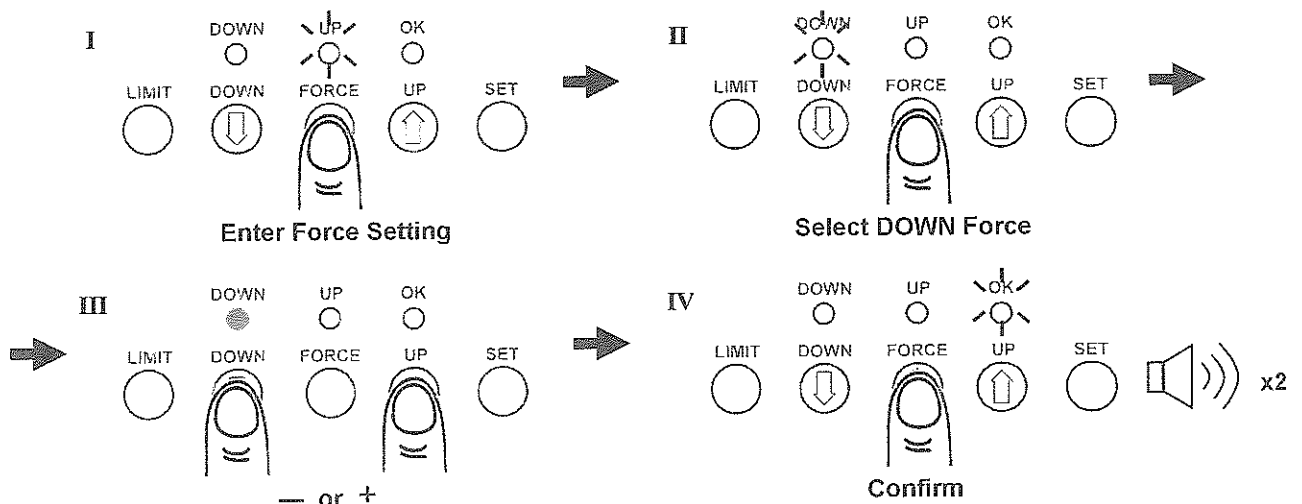

PROGRAMMING TRANSMITTER

1. To program transmitter, press "SET" button, "OK" indicator flashes twice. The unit is ready to accept a transmitter in the coming 30 seconds.

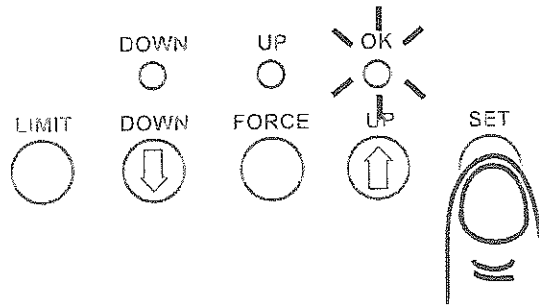

2. Press any button on the transmitter within 30 seconds.

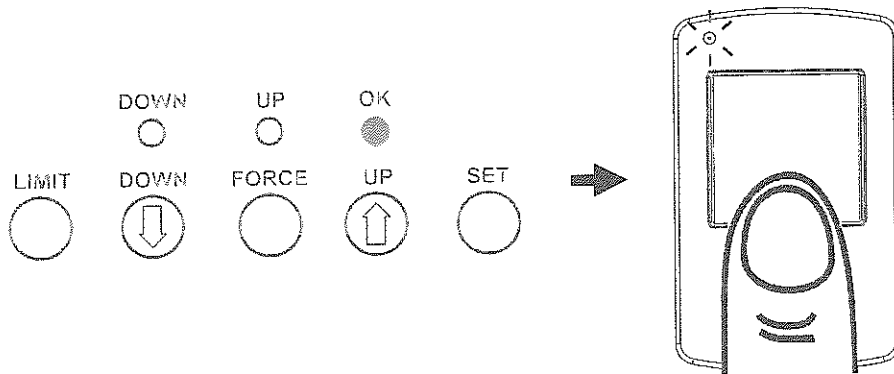

3. "OK" indicator flashes once and opener beeps twice, transmitter is set.

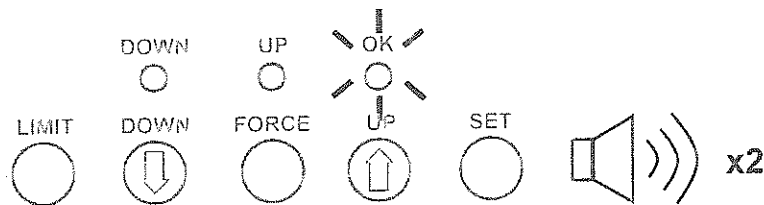

To DELETE ALL transmitters :

Press and hold "SET" button for about 7 seconds until "OK" indicator flashes and beeps twice.

SETTING AUTO-CLOSING TIMER

Auto-closing timer is turned off as default (the screw control is at fully “-”)

1. Mandatory Photo Eye* must be selected and properly connected and aligned to enable Auto-closing Timer. (* Contact your local supplier)
2. Turn the screw towards ‘+’ position to set to appropriate delay time (max. 2-1/2 minutes) for the door to auto-close after fully opened.

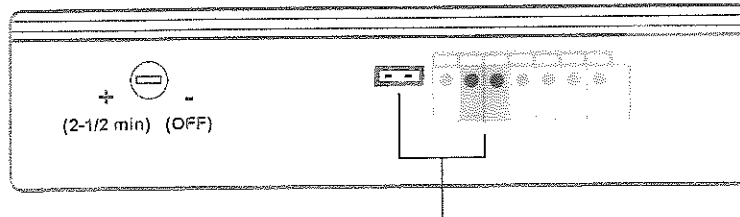
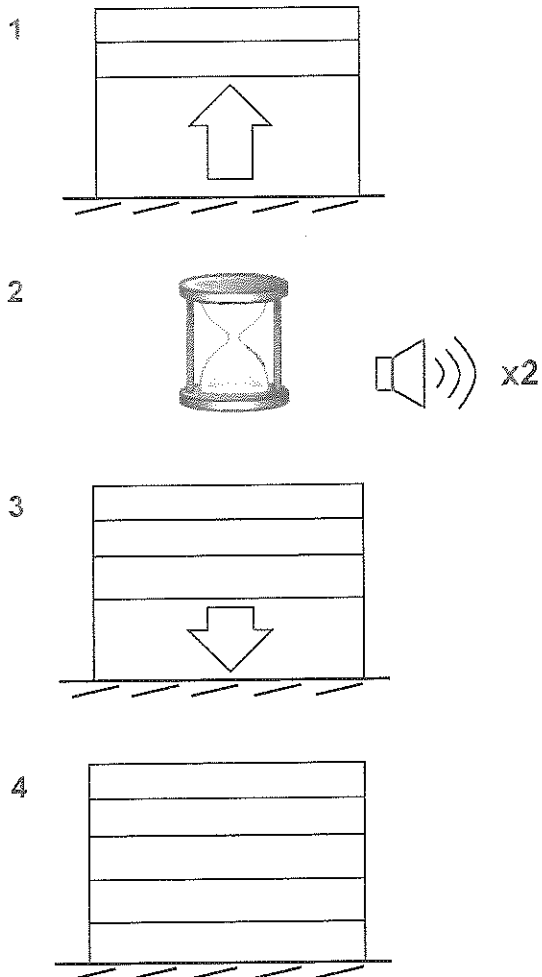

Photo Eye must be selected and connected

2. When the delay time is reached during the door at fully open position, the opener beeps and closes the door automatically.



TROUBLE SHOOTING

DOOR WILL NOT OPERATE FROM

A) Control Panel on the Unit

- » Check power, the illumination should flash upon re-connecting power.
- » IF NOT, check mains plug and fuse.
- » The Manual release is engaged.
- » Operation Direction (L/R) is set correctly.
- » Limits are correctly set, i.e. UP Limit for fully open position, DOWN Limit Switch for fully closed position.
- » Disengage and move the door manually to half-closed position, re-engage and try again.
- » Try operation with Handheld Transmitter.

B) On Handheld Transmitter

- » Check door operates correctly using the UP/DOWN buttons on the unit to prove the system is okay.
- » Try re-programming Transmitter.
- » Check battery in Transmitter is correctly fitted, and the LED indicator should illuminate upon key-press.
- » Try new battery.
- » Move aerial and try in different orientations, keeping away from steel structures and electrical cables.

DOOR OPERATES BUT FAILS TO FULLY OPEN OR REVERSES BEFORE CLOSING

- » Check manual operation for correct balance, not binding. Adjust if necessary.
- » Spray silicone lubricant into tracks. Do not grease.
- » Check/adjust safety sensitivity setting.
- » Check Limits.

BANGS HARD ON TRACK STOPS WHEN FULLY OPEN

- » Check UP Limit setting.
- » Adjust if necessary.

BANGS HARD ON GROUND AND REVERSES WHEN FULLY SHUT

- » Check DOWN Limit setting.
- » Adjust if necessary.

DOOR FAILS TO TRAVEL DOWN FROM OPEN POSITION - MOTOR RUNS AND ROLLER DOOR BALOONS

- » Check door curtain has smooth line of entry into tracks, as near vertical as possible.
- » Check door tension is not too great, reduce spring tension if necessary.
- » If the above does not cure the problem, then the door may require a weight bar to be fitted.

SHORT RANGE REMOTE CONTROL

- » Remote Control should give minimum of 6m range.
- » Check battery is correctly fitted in Transmitter.
- » Try new battery.
- » Move aerial and try in different orientations, keeping away from steel structures and electrical cables.

DOOR OPERATES BUT FAILS TO FULLY OPEN BUT REVERSES TO CLOSED POSITION

- » Reset Limits.
- » Re-adjust Sensitivity Adjustment.

POWER FAILURE

To disengage

- » Push the manual release (red handle) upwards.

To engage

- » Pull the manual release again.

PARTS-BREAKDOWN

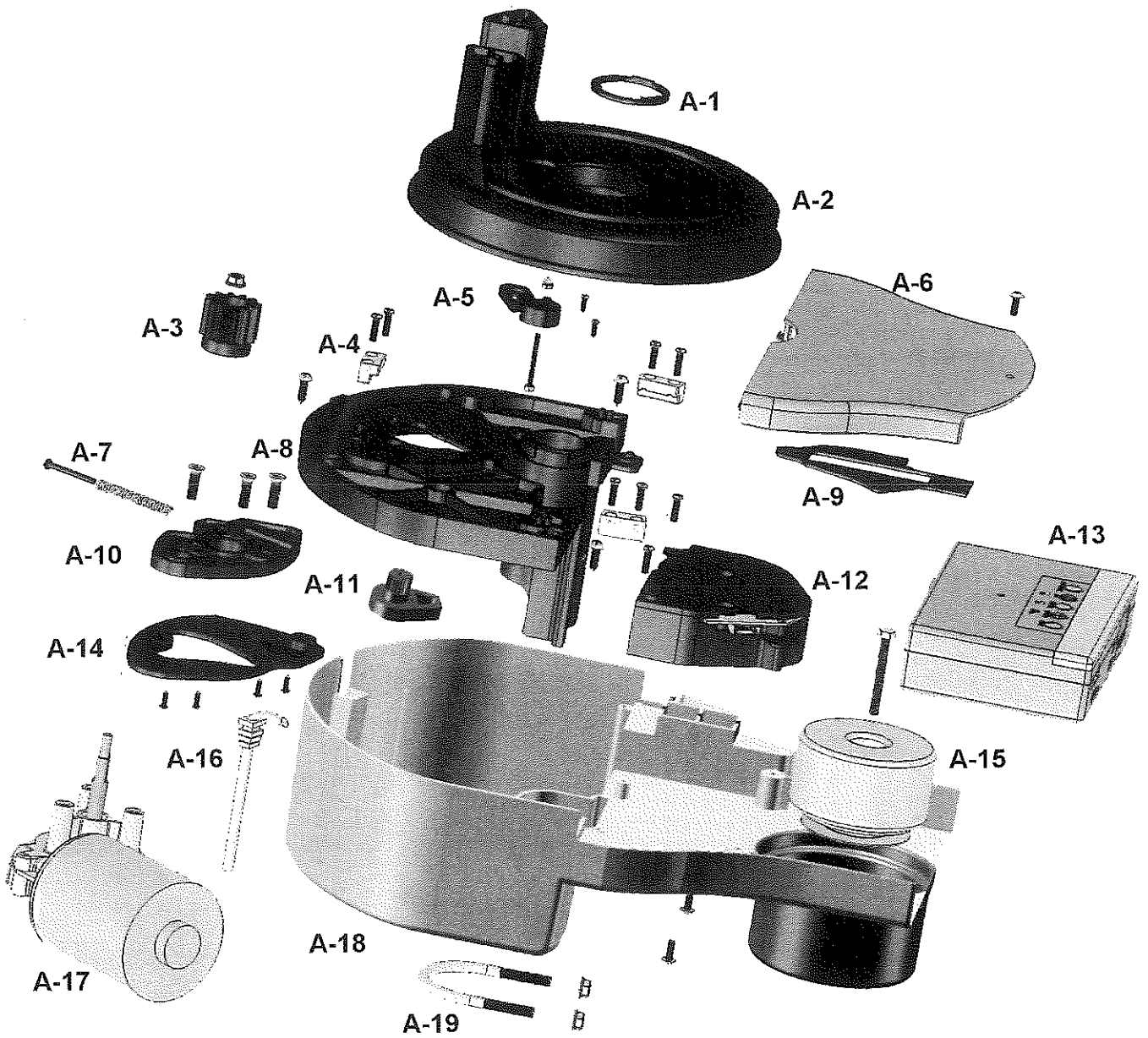

A-1	Circlip	A-11	Clutch Gear
A-2	Sun Gear	A-12	RPM Reader
A-3	Drive Gear	A-13	Control Console
A-4	Sun Gear Retainer	A-14	Release Positioning Plate
A-5	Release Lever	A-15	Transformer
A-6	Front Cover	A-16	Power Cord
A-7	Nylon Pin & Spring	A-17	Motor
A-8	Main Frame	A-18	Enclosure
A-9	Release Cover	A-19	U-bolt
A-10	Motor Support		

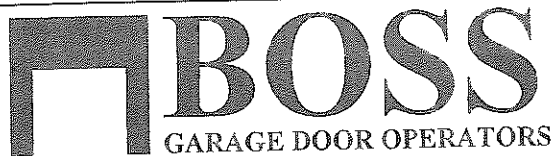

WARRANTY

Boss Garage Door Operators hereafter referred to as the Manufacturer hereby warrants:

1. Garage Door Operators to be free from defects in material and workmanship for a period of five (5) years for motors and one (1) year for Electronics and Mechanics from date of purchase, if installed by an authorized reseller, otherwise if installed by the purchaser one (1) year will apply.
2. Garage Door Operators (Commercial and Industrial Application) to be free from defects in material and workmanship for a period of three (3) months from date of purchase.
3. Where the garage door operator has been returned to the manufacturer for Warranty repairs, all costs incurred in the return will be paid for by the purchaser. If in the opinion of the manufacturer the product is faulty, all defective parts will be replaced at no charge to the purchaser.
4. Proof of purchase must be given to the manufacturer at time of Warranty claim.
5. The manufacturer reserves the right to modify any existing or future products without incurring any obligation to incorporate such modification to products already manufactured or to which this Warranty may relate.
6. Warranty only applies if this product has been installed to the Manufacturers recommendation (in the opinion of BOSS Garage Door Operators).
7. This is only for goods installed in Australia.
8. This Warranty does not apply to any defect, loss or damage arising or caused directly or indirectly by or as a result of :
 - (i) Any defect (including defects in component parts or accessories) arising from or attributable to the failure to carry out normal preventive maintenance or adjustment itself.
 - (ii) To any additional damage or deterioration arising from attributable to the operation of the Operator after it is known to be defective.
9. Exclusions to Warranty Period:
 - (i) Repair or Warranty Work - three (3) month warranty
10. Not included in Warranty:
 - (i) Batteries.
 - (ii) Fuses.
 - (iii) Globes.
 - (iv) Sensitivity adjustment.
 - (v) Hand Transmitters and receiver range.
11. Note : All Warranties will be void subject to:
 - (i) Water damage and condensation.
 - (ii) Power supply black out or surge.
 - (iii) Act of God.
 - (iv) Modification or adjustment by unauthorized persons.
 - (v) Any interference from radio (including citizen band radios or and other electronic device.
 - (vi) Preventative maintenance and regular servicing not undertaken.
 - (vii) Account not paid in full by the purchaser.
12. Subject only to the provisions of the Trade practices Act and any legislation of the State or Territory wherein the doors of the Manufacturer shall have been sold or installed (which may confer certain rights on consumers of goods and those rights by such legislation may be rendered incapable of exclusion) this Warranty supersedes and excludes all representations, warranties and conditions whether expressed or implied by law and the Manufacturer shall have no liability or otherwise than herein provided for any loss and damage (including consequential loss and damage, loss of use or profits) by reasons of delay, defective or faulty materials or workmanship, negligence or any act, matter or thing done permitted or omitted to be done by the Manufacturer.

WARRANTY

THIS WARRANTY FORM SHOULD BE COMPLETED AT TIME OF INSTALLATION

This Warranty Form should be retained by the purchaser at all times and produced with the purchase docket by the Purchaser as proof of the purchase date.

PURCHASER'S NAME: _____

PURCHASER'S ADDRESS: _____

INSTALLED BY: _____

INSTALLER'S ADDRESS: _____

INSTALLER'S SIGNATURE: _____

DRIVE UNIT SERIAL NO: _____