

PanelPro™

Sectional Door Opener SDO-4V1 Tri-Tran+

Home Owner's Manual

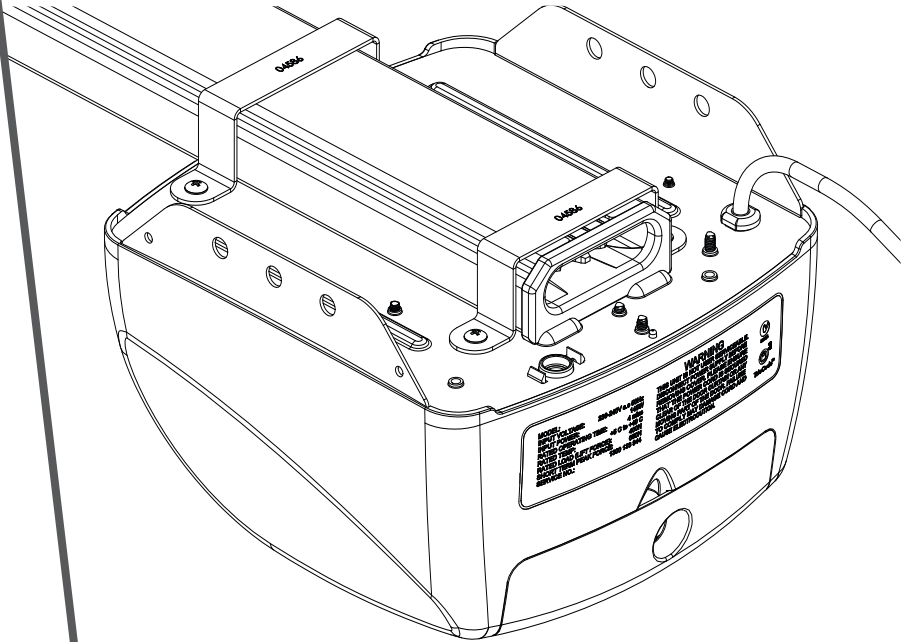

Featuring



Technology

Doc #: 161014_00
Part #: 79121
Released: 24/03/14

B&D Doors is a division of B&D Australia Pty Ltd
ABN 25 010 473 971



Table of Contents

1. Safety Rules	3
2. Features	4
3. Specifications	5
4. Operating your door	6
5. User Operating Controls	7
6. Opener Safety & Security	8
6.1 Manual Door Operation	8
6.2 Emergency Evacuations	8
6.3 Power Failure	8
6.4 Re-Engaging the Opener	8
6.5 Security - Inbuilt Locking Facility	8
7. Safety Testing	9
7.1 Test the Close Cycle	9
7.2 Testing the Open Cycle	9
7.3 Test the Manual Door Operation	9
7.4 Setting the PET Mode position	9
8. Coding Transmitters	10
8.1 Storing the Transmitter Code	10
8.2 Setting the Courtesy Light	10
8.3 Setting the Vacation Mode	10
8.4 Enabling AUX Output	11
8.5 Setting PET (Pedestrian) Mode	11
8.6 Erasing Programmed Codes	11
9. Troubleshooting Guide	12
10. Maintenance	14
10.1 Door Maintenance	14
10.2 Lubrication (every 3 - 6 months)	14
10.3 Door Service and Repair	14
10.4 Opener Maintenance	15
10.5 Removing the Battery From the Transmitter	15
11. Warranty	16
12. Optional Accessories	18
13. Service Schedule	19



1. Safety Rules

Please read these important safety rules

This automatic garage door opener is designed and tested to offer safe service provided it is installed and operated in strict accordance with the following safety rules. Failure to comply with the following instructions may result in death, serious personal injury or property damage.



WARNING!

- When operating the manual release while the door is open, the door may fall rapidly due to weak or broken springs, or due to being improperly balanced.
- Do not disengage the opener to manual operation with children/persons or any objects including motor vehicles within the doorway.
- If the door is closing and does not re-open when obstructed, discontinue use. Do not use a door with faulty obstruction sensing.



ELECTROCUTION!

- Place opener in protected area so that it does not get wet.
- Do not spray with water .
- Do not open the protective covers.
- Do not operate opener if power cord is damaged.



CAUTION:

Emergency access

Entrapment under operating door

Fall from Ladder

Entanglement in or laceration from moving door

- If your garage has no pedestrian entrance door, an emergency access device should be installed. This accessory allows manual operation of the garage door from outside in case of power failure.
- Watch the moving door and keep people away until the door is completely opened or closed. Do not operate door when persons are near the door.
- Do not allow children to play with door controls or transmitters.
- Regularly conduct Open and Close cycle testing.
- Ensure the garage door is in good working order by undertaking regular servicing.
- Wall transmitters should be installed in a location where the garage door is visible, but out of the reach of children at a height of at least 1.5m.
- Install Safety Beams (recommended).
- Ensure ladder is the correct type for the job.
- Ensure ladder is on flat ground.
- Ensure user has 3 points of contact while on ladder.
- Keep hands and loose clothing clear of door and guides at all times.
- Keep hands clear of moving door as sharp edges can cause cuts or lacerations.
- Keep the garage door balanced. Sticking or binding doors must be repaired. Garage doors, door springs, brackets and their hardware are under extreme tension and can cause serious personal injury. Do not attempt any garage door adjustment. Do not use if repair or adjustment is needed. Call for a professional garage door service.



DO NOT DO IT YOURSELF

Automatic Technology (Australia) Pty Ltd to the extent that such may be lawfully excluded hereby expressly disclaims all conditions or warranties, statutory or otherwise which may be implied by laws as conditions or warranties of purchase of a Automatic Technology (Australia) Pty Ltd Garage Door Opener. Automatic Technology (Australia) Pty Ltd hereby further expressly excludes all or any liability for any injury, damage, cost, expense or claim whatsoever suffered by any person as a result whether directly or indirectly from failure to install the Automatic Technology (Australia) Pty Ltd Garage Door Opener in accordance with the installation instructions.



2. Features

Warranty

Two (2) year/5,000 cycles full parts and labour warranty on motor, electronics and mechanical components of the opener when installed by an Automatic Technology Dealer.

Tri-Tran+ Technology

Only transmitters with the Tri-Tran+ Technology can operate with the latest Openers, reducing the chance of interference from other radio frequency sources. Tri-Tran+ transmitters have the ability to code into earlier model openers.

Code Hopping Technology

Every time a transmitter is used a new security code is generated from over 100 billion possible code combinations. This greatly enhances the security of the system and makes "code grabbing" a thing of the past!

Multi-Channel Transmitter

Multi-channel transmitters allow you to operate other devices such as an adjoining garage door or automated gate from the same handy unit.

S-ALPS (Semi Automatic Limits Positioning System)

The S-ALPS system does away with manual adjustment of the door's limits position using mechanical parts, such as cams and microswitches.

ISS (intelligent safety obstruction system)

While the door is performing a close cycle, should it hit an obstacle or be restricted in some manner, it will automatically reverse. The amount of force the door should encounter before reversing is automatically adjusted by the doors control system during the initial installation of the automatic door opener. The door will also stop if restricted whilst opening. The Safety Obstruction Force should be checked monthly.

Manual Release

The manual release handle allows the door to be operated by hand in the event of a power failure.

Self Locking

There is no need to manually lock your garage door, as the opener 'positively' locks the door when closed.

Service Fault Indicator

Flashing LEDs on the control panel easily identify operational problems or service requirements.

Dynamic Door Profiling

Changing door characteristics are automatically compensated for and "learnt" with each operation of the door.

Safety Beam (optional)

The opener has an input to connect a Safety Beam for extra safety.

Courtesy Light

The courtesy light comes on automatically for three minutes whenever the door is activated.

The courtesy light automatically switches on for approximately three (3) minutes when operating the door. This can also be programmed to turn on and off from a transmitter. (Refer to 8.2 for information)

Vacation Mode

A transmitter can be programmed to disable the garage door opener radio receiver. This is ideal if the door is to be left idle for prolonged periods. (Refer to 8.3 for information)

Auxiliary Output

You can program a spare button on your remote control transmitter to operate this output to control items that can be switched using a momentary close. (Refer to 8.4 for information)

Pet (Pedestrian) Mode

A transmitter can be programmed to open the door partially to allow pets access to the garage. The default PET Mode height can be adjusted to a desired position. (Refer to 7.4 for information). To code a transmitter button to operate PET mode refer to 8.5 for information.



3. Specifications

Technical Specifications	
Power supply	230V - 240Va.c. 50Hz
Maximum door opening: Width: Height: Weight:	4950mm (13.5m ²) 2440mm 100kg
Minimum headroom	25mm
Short Term Peak Force	650N (65kg)
Rated force	400N (40kg) with Chain
Nominal force	150N (15kg)
Receiver type	UHF Multi-frequency FM Receiver
Receiver code storage capacity	8 X Tri-Tran+ 4-button Transmitters
Transmitter frequency	433.47, 433.92, 434.37MHz
Coding type	Tri-Tran+ Technology
Number of code combinations	Over 100 billion random codes
Code generation	Non-linear encryption algorithm
Transmitter battery	CR2032 (3 Volts)
Courtesy light	Festoon style lamp 24volts 15 watts

Note: Intermittent operations may occur in areas which experience very strong winds. The strong wind puts extra pressure on the door and tracks which may in turn intermittently trigger the safety obstruction detection system.



4. Operating your door

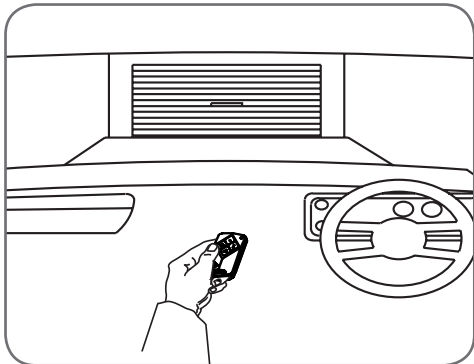

Fig. 4.1

For maximum efficiency of your opener, your garage door must be in good operating condition.

An annual service of your garage door by an Approved Dealer is recommended.



CAUTION: Activate the opener only when the door is in full view, free of obstructions and with the opener properly adjusted. No one should enter or leave the garage while the door is in motion. Do not allow children to play with or near the door.



ELECTROCUTION! This opener is a mains voltage plug-in domestic appliance and there are no user serviceable parts inside this opener.

Transmitter

- To operate the opener, press the programmed transmitter button until your door begins to move (usually 2 seconds). Make sure you can see the door when you use the transmitter.
- If you are in a vehicle you should aim the transmitter through your windscreen (**Fig. 4.1**).
- Check that the door is fully closed before you drive away.
- If you press the transmitter whilst the door is moving the door will stop. The next press of the transmitter will move the door in the opposite direction.

The transmitter may also be programmed to operate the following features (Refer to Section 8 for full details):

- Turn the courtesy light on and off without operating the door,
- Put the garage door opener into "Vacation Mode" where it will not respond to any transmitters.

NOTE: Additional transmitters may be purchased at any time.



5. User Operating Controls

Button (Fig 5.1)	Function
1. OPERATE	Opens/stops/closes the door
2. CODING LED (Red)	Flashes when a code is being stored or when the transmitter button is pressed
3. DOOR CODE (Blue)	Is used for storing or erasing transmitter buttons for door operation
4. DOOR STATUS LED (Yellow)	Illuminates when Service is due.
5. OPEN LED (Green)	Illuminates and flashes as the door opens and remains on when the open limit position has been reached.
6. CLOSE LED (Red)	Illuminates and flashes as the door opens closes, and remains on when the close limit position has been reached.
7. SET (Orange)	Is used during installation. The SET button is also used to program the PET (Pedestrian) position and to re-initialise the opener.

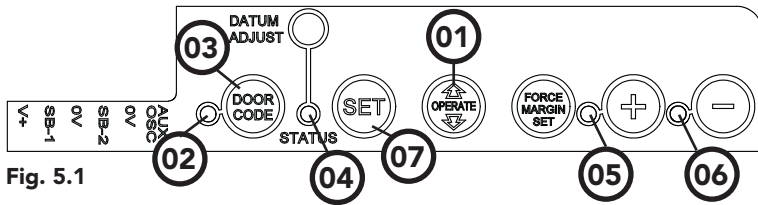

Fig. 5.1

Door Status Indicators	OPEN LED (green)	CLOSE LED (red)	Beeper
Open	On		
Close		On	
Opening	Flashing		
Closing		Flashing	
Door travel stopped	Flashing	Flashing	
Door obstructed when opening	Flashing		Beeps while door is moving
Door obstructed when closing		Flashing	Beeps while door is moving
Opener overloaded	Alternating flashes	Alternating flashes	
Mains power interrupted	Rapid flashes		



6. Opener Safety & Security



WARNING! When operating the manual release (while the door is open) the door may fall rapidly due to weak or broken springs, or due to being improperly balanced.

Do not disengage the opener to manual operation with children/ persons or any objects including motor vehicles within the doorway.

MANUAL RELEASE

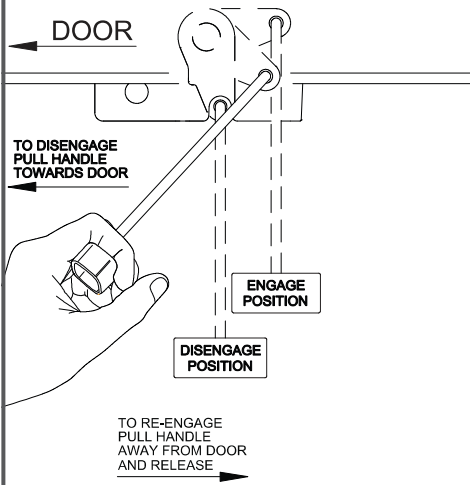

Fig. 6.1

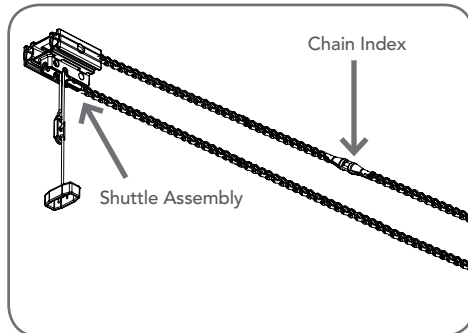

Fig. 6.2

6.1 Manual Door Operation

To disengage the opener from the door (preferably with the door in the closed position), pull down on the string handle on an angle towards the door (**Fig 6.1**). This will allow you to manually open or close the door.



CAUTION: Do not use the string handle as a mechanism to open the door. Failure to comply may cause serious injury.

To re-engage the opener pull the string handle away from the door - see 6.4 Re-Engaging the Opener.

6.2 Emergency Evacuations

In emergencies the garage door can be disengaged from the opener, via the manual release cord and the door opened manually. The manual release cord should be a maximum of 1.8m from the ground. The cord can be adjusted for special considerations.

6.3 Power Failure

When there is a power failure, the opener will be unable to automatically open or close your garage door. To use your door whilst there is no power you will need to disengage the opener and use the door manually – see 6.1 Manual Door Operation.

6.4 Re-Engaging the Opener

When the door has been disengaged from the opener, the shuttle assembly, attached to the manual release cord, can move up and down the chain. Re-engage the opener (**Fig 6.1**) (preferably with the door open to waist height) and then press the programmed transmitter button, the motor will run until the shuttle assembly engages the chain index (**Fig 6.2**), you will hear it click into place. Then the door will operate as normal.

6.5 Security - Inbuilt Locking Facility

DO NOT lock your door when your opener is engaged as it has inbuilt locking facility. With the opener engaged your door will be locked whether the power is on or off.



CAUTION: When the opener is manually disengaged, the door is no longer locked. To lock the door manually, re-engage the opener after the door is closed.



7. Safety Testing

7.1 Test the Close Cycle

- Press the transmitter to open the door. (Fig 7.1)
- Place a piece of timber approximately 40mm high on the floor directly under the door (Fig 7.2).
- Press the programmed transmitter to close door.
- The door should strike the object and re-open.



CAUTION: Take care when completing a safety test. Failure to follow this warning can result in serious personal injury and/or property damage.

7.2 Testing the Open Cycle

- Press the transmitter to close the door (Fig. 7.1).
- Press again to open the door.
- When the door reaches approximately half way, firmly grab the door's bottom rail - the door should stop.

If the door does not reverse readily when closing, or stop when opening, put the door into manual and contact your installer immediately for a door service.



WARNING! If the door is closing and is unable to re-open when obstructed, discontinue use. Do not use a door with faulty obstruction sensing. Contact your dealer for support.

7.3 Test the Manual Door Operation

Periodically disengage the opener (Section 6.1) and manually operate the door. The door must be smooth to operate by hand. The force required on the bottom rail should not exceed 15 kg.

7.4 Setting the PET Mode position

When activated, PET mode drives the door to the preset position from the close position.

- Drive and stop the door at the desired PET mode open position by pressing the transmitter button coded for Open/Stop/Close operation.
- Press and hold the OPEN button on the opener for six (6) seconds until the OPEN and CLOSE LED's are lit to record the new PET position.

To program a transmitter button to operate PET mode refer to 8.3 Code Transmitter for PET Mode.

Periodically test if a PET mode button is pressed, while the door is moving, the door will stop or when the door is in the PET position, the door will close.

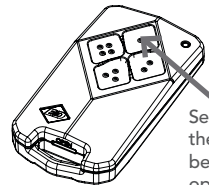

Select the button on the transmitter that has been programmed to operate the door.

If transmitter is not programmed, Refer to Section 8 to program transmitter.

Fig. 7.1

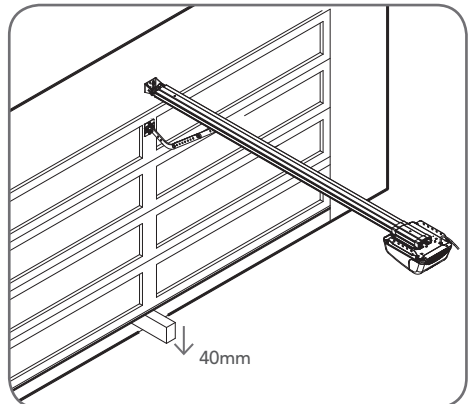

Fig. 7.2



8. Coding Transmitters

8.1 Storing the Transmitter Code

The opener can only operate from transmitters that have been programmed into its receiver. The receiver needs to learn the codes of any transmitter that will be used with the operator. Up to eight (8) codes can be stored in the receiver's memory.

- Ensure that the battery is inserted in the transmitter.
- Press the DOOR CODE button and release. The DOOR CODE LED will illuminate to indicate the opener is in Code Learn mode. If a valid code is not stored within 15 seconds the opener will exit Code Learn. **(Fig 8.1)**
- Press one of the four (4) buttons on the transmitter for two (2) seconds, the DOOR CODE LED will begin to flash, pause for two (2) seconds, then press the same button again for two (2) seconds.
- The transmitter button is now coded - press to test.

8.2 Setting the Courtesy Light

Although the courtesy light comes on with each operation of the opener, it may also be controlled by a transmitter without operating the door.

- Press the DOOR CODE button twice - the DOOR CODE LED and courtesy light will both illuminate.
- Press one of the four buttons on the transmitter for two (2) seconds, pause for two (2) seconds, then press the same button again for two (2) seconds. The DOOR CODE LED will illuminate for one second then go out.
- Press the transmitter button to test.

8.3 Setting the Vacation Mode

The opener can be programmed into a "Vacation Mode" where the opener will not respond to any transmitter except one preprogrammed unit.

- Press the DOOR CODE button three (3) times - the DOOR CODE LED will illuminate and the courtesy light will flash slowly.
- Press one of the four (4) buttons on the transmitter for two (2) seconds, the DOOR CODE LED will begin to flash, pause for two (2) seconds, then press the same button again for two (2) seconds.
- The DOOR CODE LED will illuminate for one second and then go out, and the courtesy light will also switch off. This indicates the code has been stored.
- Press and hold the transmitter button for five (5) seconds to set Vacation Mode. The DOOR CODE LED will stay lit while Vacation Mode is active.
- To reset Vacation Mode, press the same button for two seconds, until the DOOR CODE LED turns off.



ELECTROCUTION! The button cover is the only cover that should be removed. All other covers must remain in place.



CAUTION: Be careful not to press the operate button while removing the button cover as the door will start to move.

IMPORTANT NOTE: Only Tri-Tran⁺ Technology Transmitters are compatible with this SDO-4V1 product.

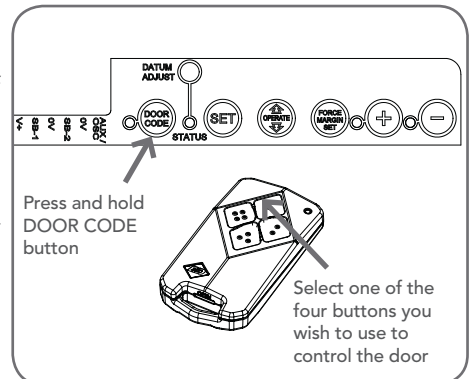

Fig. 8.1



8. Coding Transmitters

8.4 Enabling AUX Output

- Press the DOOR CODE button four (4) times - the DOOR CODE LED will illuminate and the courtesy light will flash quickly. **(Fig 8.2)**
- Press one of the four (4) buttons on the transmitter for two (2) seconds, the DOOR CODE LED will begin to flash, pause for two (2) seconds, then press the same button again for two (2) seconds. The DOOR CODE LED will illuminate for one second then go out.
- Press the transmitter button to test.

8.5 Setting PET (Pedestrian) Mode

The PET mode position is set during installation.

- Press the DOOR CODE button five (5) times - the DOOR CODE LED will illuminate and the courtesy light will flash quickly (twice per second).
- Press one of the four (4) buttons on the transmitter for two (2) seconds, the DOOR CODE LED will begin to flash, pause for two (2) seconds, then press the same button again for two (2) seconds.
- The DOOR CODE LED will illuminate for one second and then go out, and the courtesy light will also switch off. This indicates the code has been stored.
- Press the transmitter button to test.

8.6 Erasing Programmed Codes

If the DOOR CODE button is pressed and held for six (6) seconds the DOOR CODE LED will blink rapidly for one second to indicate that all programmed codes have been erased.

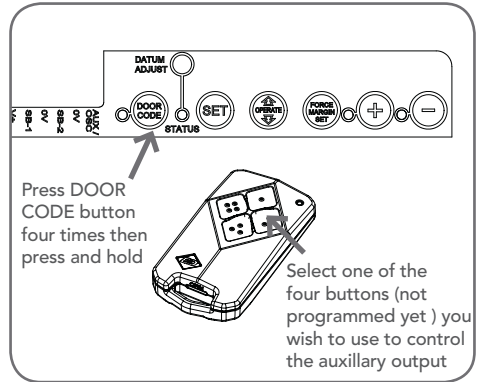

Fig. 8.2

9. Troubleshooting Guide

Symptom	Possible cause	Remedy
The door stops or moves very slowly	Garage door in poor condition e.g. springs may be broken	Check the door's operation - see monthly maintenance (Section 10.1)
The opener does not work from the transmitter	The opener does not have power	Plug a device of similar voltage (e.g. a hairdryer) into the power point and check that it is OK
	The battery in the transmitter is flat	Replace the battery (Section 10.5)
	Transmitter does not contain Tri-Tran+ Technology	Check that the transmitter has grey buttons and the model number on the back displays V2. Contact dealer for support if otherwise.
	The opener has been put into "Vacation Mode"	Turn off "Vacation Mode" (Section 8.3, step e)
	The transmitter button is not programmed to operate the door.	See coding transmitter procedure (Section 8.1)
The chain moves but the door remains stationary	Door Code LED is flashing yet the opener is not working.	Ensure the correct button on the transmitter is being pressed.
	The opener is disengaged	Re-engage the opener (Section 6.4)
Motor is running but chain is not moving	Damage motor assembly	Contact your dealer for support.
The transmitter range varies or is restricted	Variations are normal depending on conditions e.g. temperature or external interference	See instructions for correct use of transmitter (Section 4)
	The battery life is exhausted	Refer to battery status (Fig 10.2)
	Position of the transmitter in the motor vehicle	Change the position (Section 4)
The door reverses for no apparent reason	This may occur occasionally from environmental conditions such as areas that are windy, dusty or have extreme temperature changes.	Put the door into manual (Section 6.1, take note of the CAUTION) and contact your dealer.
	If Safety beams are installed they may be partially obstructed.	Ensure the beam path is not obstructed. If continues, contact your dealer.
The door opens but will not close	Safety Beam (Optional Accessory) not operating correctly	Contact your dealer for support

9. Troubleshooting Guide

Symptom	Possible cause	Remedy
Courtesy Light flashes and the opener beeps 5 times after each operation	The opener has reached the number of cycles recommended before servicing.	Contact your dealer and arrange a door service. Alternatively press SET button once to reset the service counter.
The STATUS LED has started to flash and is beeping numerous times	A Fault has been detected. The fault will be active each time an attempt is made to operate the door.	Record opener function in (Fig 9.1) then press the SET button once to reset the opener. If the fault continues to be tripped contact your dealer for support.
The Open (Green) LED and Close (Red) LED are flashing alternatively	Opener is overloaded	Discontinue use and contact your dealer for support.
The Open (Green) LED continues to flash	Door obstructed when opening	Clear away any obstructions and test door opens correctly. (If door is damaged, contact your dealer).
The Close (Red) LED continues to flash	Door obstructed when closing Limits may be cleared	Clear away any obstructions and test door closes correctly. (If door is damaged, contact your dealer). Remove all power sources (including the battery backup). Wait till all lights are out (10-15 secs), then reconnect power. If Red LED is flashing, limits are not set. Contact dealer immediately and discontinue use.

If You Need a Service Call

If the opener needs a service please call the dealer who installed the garage door opener (their contact details are usually on a sticker on the back of your garage door). For product assistance contact 13 62 63 within Australia.

BEFORE CALLING you should have the following information to assist in providing the appropriate service:

1. Has anything happened since the opener last operated OK, e.g. a storm, a jolt to the door etc.?
2. What is the current light status on the opener?
3. Manually disengage the door (Section 6.1). How easy is it to manually open and close the door?
4. What model is the opener? (Model no. information is located at the rear of the opener)
5. Who installed the opener? (Dealer details should be on a sticker on the back of your garage door)
6. When was it installed? (If known)

Date	Time	Number of Beeps

Fig. 9.1

10. Door Maintenance



WARNING! Failure to maintain your garage door may void the warranty on your garage door opener.



DO NOT DO IT YOURSELF:

Door adjustments should only be carried out by experienced persons, as this function can be dangerous if not performed under strict safety procedures.



ELECTROCUTION! Disconnect the opener power cord from the mains power before making any door repairs / maintenance or removing the opener button cover.

10.1 Door Maintenance

Whilst your opener does not require any periodic maintenance, the door that it is fitted to, does. Your garage door is a large, heavy, moving object and should be tested regularly to ensure it is in good condition. A poorly maintained door could cause fatal / serious injuries or damage to property.

- Frequently examine the door, particularly the cables, springs and mountings for signs of wear, damage or imbalance. **DO NOT USE** if repair or adjustment is needed since a fault in the installation or an incorrectly balanced door may cause injury.

10.2 Lubrication (every 3 - 6 months)

To ensure a long and trouble free life for your door the following is recommended:

- Guide Tracks: Clean the internal sections of the guide tracks with a cloth dampened with mineral turps or methylated spirits.
- Steel Hinges (if fitted): Sparingly lubricate with an all-purpose machine oil. Also lubricate wheel to axle bearings.
- Plastic Hinges: No lubrication is generally required; however silicon spray may be used if necessary.
- Springs: If accessible wipe over with an oily rag.

10.3 Door Service and Repair

If correct maintenance and servicing are not carried out, warranty may be voided. To keep your door running well, it is recommended that your door be serviced by an experienced technician, every **12 months** or earlier if required:

- Lifting Cables (if fitted): Check for wear through rubbing. If there is fraying or signs of corrosion contact your dealer immediately and discontinue use, leaving door in the closed position.
- Fasteners: Check all screws, nuts and bolts to ensure they are secure.
- Spring Tension: It is natural for springs to lose tension. Should the door become hard to operate or completely inoperative, contact your dealer.



10. Opener Maintenance

10.4 Opener Maintenance

To ensure a long and trouble free life for your opener the following is recommended:

- Monthly: Run the Safety Testing procedures in Section 7 to ensure garage door is fit for use.

NOTE: If the door does not operate smoothly, call your nearest dealer.

10.5 Removing the Battery From the Transmitter

(Battery Type: 3V Lithium Battery CR2032).

Use a non-metallic object (e.g. pen) to remove the battery. (**Fig. 10.1**). To test the battery is working, press and hold a transmitter button; (**Fig. 10.2**).

Light Status	Battery Status
Solid	OK
Flashing	Requires replacement
No light	Requires replacement

Fig. 10.2

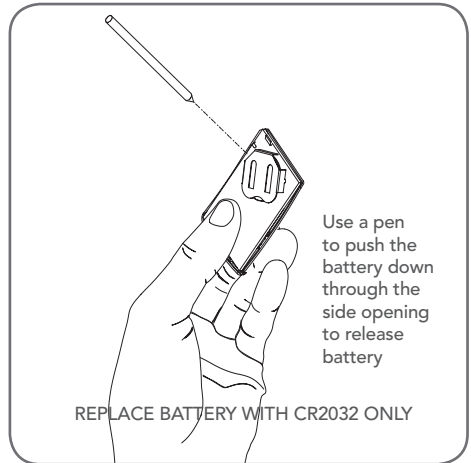

Fig. 10.1

11. Warranty

Product: PanelPro™ SDO-4V1 Tri-Tran†

Purchased from: _____ Purchaser: _____
(described as "you" below)

Address: _____ Installed by: _____

Installed on (date): _____ Invoice No: _____

1. MAKING A CLAIM -

To make a warranty claim you must:

- produce a copy of the receipt of purchase, together with this warranty certificate with the above details completed; and
- where the Product has been sold by B&D, make all warranty claims directly with B&D by sending it to B&D at the relevant address set out in paragraph 2 below; or
- where the Product has been sold by an approved distributor, make all warranty claims directly with the approved distributor. If you are unsure of the correct address of the approved distributor from which you purchased the product, you can send your claim to B&D with the rest of the above details completed, including the original invoice number, and we will forward it to the distributor.

You are responsible for the expense of making a claim under this warranty.

2. B&D OR APPROVED DISTRIBUTORS ONLY -

This warranty is in addition to any statutory, non-excludable guarantees or warranty rights under Australian or New Zealand laws (as applicable). This warranty applies only to Products sold by B&D or its approved distributor. "B&D" means in Australia - B&D Doors of 34 – 36 Marigold St, Revesby NSW 2212 and in New Zealand - B&D Doors (NZ) Limited of 30C Allens Road, East Tamaki Auckland. "Approved distributor" means an approved reseller of B&D products purchasing on open account, from B&D, for the purpose of supplying those products to end users.

3. WHAT THE WARRANTY COVERS -

B&D warrants, subject to paragraph 4, that it will, at its option, either repair or replace (in a manner B&D considers reasonable) any proven defects:

- in installation for a period of one year from the date of installation where the PanelPro™ (Product) has been installed by B&D or its approved distributor;
- in materials, manufacture or workmanship in the Product, as follows:
 - for all components of the Product that make up the power head (including any track assembly) that is attached to a garage door and that are installed by B&D or an approved distributor, the warranty will be valid for a period of two (2) years or 5,000 cycles, whichever ever occurs first, provided that the Product is serviced annually by B&D or its approved distributor;
 - for all components of the Product that make up the power head (including any track assembly) that is attached to a garage door and that are not installed by B&D or an approved distributor, the warranty is valid for a period of one year, provided that all costs of disconnection, reinstallation and return freight are to be borne by you;
 - for all other components of the Product the warranty is valid for a period of one year; and

in each case the warranty applies from the later of the date of purchase, delivery or installation by B&D or an approved distributor (as applicable).

4. WHAT THE WARRANTY DOES NOT COVER -

This warranty does not cover:

- batteries or globes - B&D will not be liable for any defect or failure in them;
- adjustments - (as described in the Instruction Manual provided with the Product) which are not defects - you will need to pay for any service calls for adjustments;
- model modifications - B&D will not be required to incorporate modifications made to existing/future Product models;
- travel expenses - incurred by B&D or its approved distributor in either travelling to and from or transporting the Product to/from areas outside a capital city metropolitan area - you will need to pay for these expenses; or
- additional access expenses - incurred by B&D or an approved distributor in obtaining access where the Product is not readily accessible - you will need to pay for those additional expenses.



11. Warranty

5. WHAT VOIDS THE WARRANTY -

Subject to paragraph 6, this warranty does not extend to, and B&D will be relieved of, all obligations, responsibilities and liabilities in the event that defects in the Product are directly or indirectly, in the opinion of B&D, due to or resulting from:

- a. unreasonable use - the Product not being used correctly in accordance with the Instruction Manual or other unreasonable use;
- b. instructions - failure to observe any instructions or directions (including "warning" notifications in the Instruction Manual), provided with the Product or given to you;
- c. other devices - the Product being fitted to any door or other closing device which is not of the type or condition defined in the Instruction Manual as suitable for installation of the Product;
- d. installation or adjustment - faulty installation or adjustment of the Product or door to which the Product is connected where such installation or adjustment is not carried out by B&D or its approved distributors;
- e. unauthorised acts - modifications or repairs made or attempted to be made by you or any unauthorised person;
- f. service - lack of proper maintenance, service or care of the door and Product;
- g. outside control - events or acts beyond the reasonable control of B&D;
- h. settings - use with doors locked or operation of the Product with excessively high opening or closing force settings
- i. wiring - faulty electrical wiring of structures to which the Product is affixed;
- j. interference - radio (including citizen band transmissions) or other electronic interference;
- k. water damage - including effects from rust and corrosion);
- l. salt - salt corrosion or damage to the surface coatings or base materials due to environmental conditions (such as proximity to the sea-front or similar corrosive conditions).
- m. continuous operating time - maximum continuous operating time exceeding 1 minute in 10;
- n. maximum operating force – the operating force exceeding 15kg* (150 Newton) when moving the door manually to the open or closed position;
- o. door size – the door surface area exceeding 13.5m²;
- p. modifications - any unauthorised modification to the Product;
- q. insects damage - damage caused by insects; or
- r. non-residential use – installation of a residential garage door opener in a commercial or industrial premises or in a dwelling other than a single-family dwelling.

6. STATUTORY GUARANTEES OR WARRANTIES –

Australia

If you are a consumer under the Australian Consumer Law, our goods come with guarantees that cannot be excluded under the Australian Consumer Law. You are entitled to a replacement or refund for a major failure and for compensation for any other reasonably foreseeable loss or damage. You are also entitled to have the goods repaired or replaced if the goods fail to be of acceptable quality and the failure does not amount to a major failure.

This warranty certificate and other statements contained in this document or other B&D documents given to you do not exclude, restrict or modify the application of all or any of the provisions of the Australian Consumer Law.

New Zealand

This warranty certificate and other statements contained in this document or other B&D documents given to you do not exclude, restrict or modify the application of the New Zealand Consumer Guarantees Act (collectively defined as the "Act"); or the exercise of rights conferred by other statutory provisions which cannot be excluded, restricted or modified, provided that to the extent that the Act or other statutory provision permits B&D to limit its liability for a breach of a statutory guarantee or warranty, B&D's liability for such breach is limited to the payment of the cost of replacing the Product or acquiring an equivalent Product or repairing the Product.

In Australia, this warranty is given by B&D Australia Pty Limited (ABN 25 010 473 971) of B&D Doors of 34 – 36 Marigold St, Revesby NSW 2212, phone 13 62 63 and email enquiries@bnd.com.au. In New Zealand, this warranty is given by BD Doors (NZ) Limited of 30C Allens Road, East Tamaki, Auckland, phone 09-273 8600 and email enquiries@bnd.co.nz

This warranty document is not intended to create a contract between B&D and the purchaser.



NOTES:

1. * The door that the Product is used with should be balanced in such a way that the user is able to open or close the door manually using a force not greater than 150 Newton (15 kg), other than to initially cause the door to start moving, which may require force in excess of that specified in this paragraph.

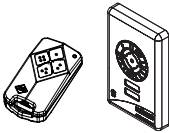

12. Optional Accessories

There are a range of additional accessories for your added convenience and security. Contact your dealer for installation of these accessory items.

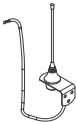
		<ul style="list-style-type: none"> • Safety Beams - Provides additional protection if the door is closing onto your property or person. Simply breaking the beam "stops" the door!
<p>IMPORTANT NOTE: Only Tri-Iran™ Technology Transmitters and Keypads are compatible with this PanelPro™ SDO-4V1 product.</p>		<ul style="list-style-type: none"> • Keyring Transmitter - Ideal for personal use when entry into the house may be via the garage. • Wall Button Transmitter - Allows you to operate the opener within 10 metres of the door. Ideal for mounting inside the house.
		<ul style="list-style-type: none"> • Wireless Keypad - The entry keypad allows entry to the garage without using a transmitter.
		<ul style="list-style-type: none"> • External Antenna - For sites where radio range may be reduced.

13. Service Schedule

Year / Approx. Cycles	Date	Details
1 / 3,000		
2 / 6,000		
3 / 9,000		
4 / 12,000		
5 / 15,000		

B&D Doors is a division of B&D Australia Pty Ltd
Phone: 13 62 63
Website: www.bnd.com.au



Is your opener beeping and flashing?

**It may be time for a service
(for more details see section 10.5)**

**For a service contact your dealer using
the details below...**



Dealer:

