



AUTOMATIC GARAGE DOOR OPENER MPC-2 OWNER'S HANDBOOK

Congratulations on the purchase of your B&D Controll-A-Door. This is a sophisticated unit using the latest microprocessor technology. You will appreciate the many features and high quality built into the product.

SOME HELPFUL HINTS

- * Note how to disengage the unit in case there is a power failure and you need to use the door manually. It is quite easy. See page 3.
- * Don't turn off at the power point, except for servicing or if you are going on holidays. If the power is off for more than approximately 3 weeks the back-up battery may be discharged and the 'memory' lost. The door travel limits and your code will need to be reset. See page 4.
- * Do not allow water, or other liquids, to enter the motor, wall unit or hand transmitter.
- * Ensure the centre-lift lock on your B&D Roll-A-Door is UNLOCKED before operating your Controll-A-Door.
- * Please read this booklet and keep it in a safe place for future reference.



WE STRESS THAT YOUR B&D CONTROLL-A-DOOR IS NOT A CHILD'S PLAYTHING. BE AWARE OF WHO MAY USE THE UNIT AND ENSURE THAT IT IS OPERATED WITH CARE AND AS INSTRUCTED.

DISTRIBUTORS B&D AUSTRALIA

NSW Office: B&D Australia, 34-36 Marigold Street, Revesby 2212. Ph: (02) 722 5555.
Qld Office: B&D Australia, 37-47 Cobalt Street, Carole Park 4300. Ph: (07) 271 2500.
Vic Office: B&D Australia, Canterbury Road, Kilsyth 3137. Ph: (03) 728 1566.
SA Office: B&D Australia, 5 Peckarra Street, Regency Park 5010. Ph: (08) 340 3111.
WA: Osborne Metal Industries Pty. Ltd., 225 Balcatta 6021. Ph: 344 3333.
Tas: Tom Moore & Son, 86 Bass Highway, Coobee 7320. Ph: (004) 31 4388

**B&D Australia is a Division of Clyde Industries (Incorporated in NSW)
A.C.N. 000 002 031**

HOW TO OPERATE

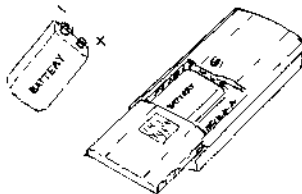
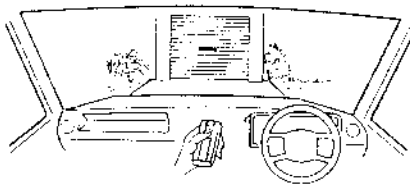
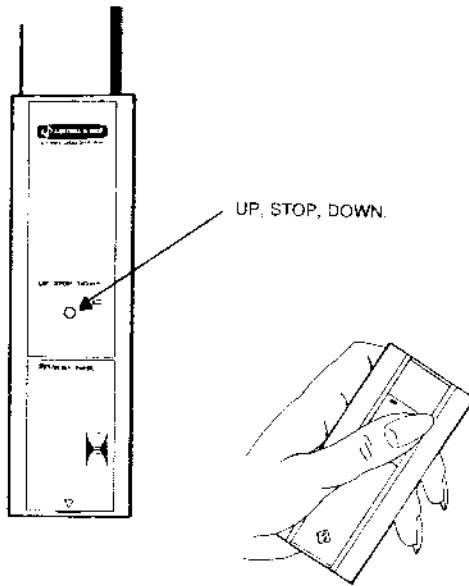

Make sure the lock on your Roll-A-Door is UNLOCKED before operating your Control-A-Door.

WALL CONTROL PANEL

Press UP.STOP.DOWN to OPEN or CLOSE the door.

HAND TRANSMITTER

Press the button for ½ second to OPEN or CLOSE the door.

IMPORTANT: The range for the hand transmitter to reverse or stop the door is always less than to start the door.

- * Always have the door in view when operating.
- * Aim through windscreen (if you are in a car).
- * Check that door is fully closed before driving away.

Pressing the hand transmitter, or UP.STOP.DOWN, while the door is moving down will send the door back up.

Pressing the hand transmitter or UP.STOP.DOWN while the door is going up will stop the door.

Next time the hand transmitter or UP.STOP.DOWN is pressed, the door will close.

HOW TO CHANGE THE TRANSMITTER BATTERY

Slide off battery cover from back of transmitter. Remove the battery, and place new battery correctly in the terminal rest. Replace cover.

SERVICING

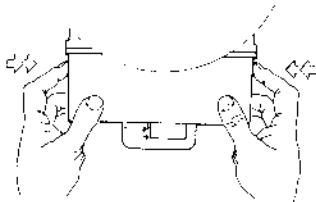

HOW TO CHANGE LIGHT GLOBES

Bulb types: 240V 40 watt plain candle, screw fitting ... available from B&D Dealers.

Turn off at power point. Press light diffuser in at either end and tilt away from handle. Unscrew globes anti-clockwise and replace. Snap light diffuser back into place.

Turn the power back on, press UP.STOP.DOWN and let the door close to reconfirm the memory.

POWER FAILURE

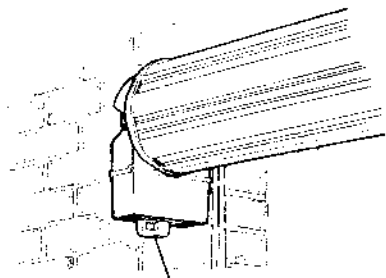

DISENGAGEMENT HANDLE

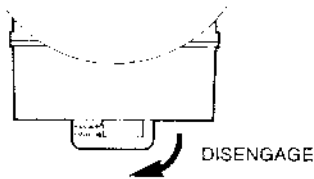

DISENGAGE

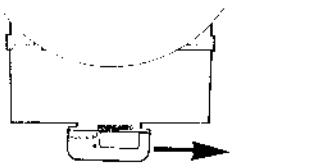

RE-ENGAGE

HOW TO DISENGAGE YOUR CONTROLL-A-DOOR for MANUAL OPERATION

To disengage:

Pull handle down firmly, and away from the wall (for LHS installed unit).

Pull handle down firmly, and towards the wall (for RHS installed unit).

To re-engage:

Move handle towards the wall (for LHS installed unit).

Move handle away from wall (for RHS installed unit).

When the power resumes:

The UP.STOP.DOWN light will flash. Your transmitter code will be remembered.

Make sure the drive unit is engaged.

Press UP.STOP.DOWN (or the hand transmitter).

Allow the door to close fully. (This allows the Controll-A-Door to reconfirm its memory).

WARNING: THE AUTOMATIC REVERSING SYSTEM WILL NOT OPERATE ON THIS FIRST DOWN MOVEMENT!

If the door is already closed when UP.STOP.DOWN is pressed, or if there has been a short blackout while you have been out, the door will try to go down, then go up a short way, down again and then it will open fully.

ACCESSORIES



TURN AND PULL CORD

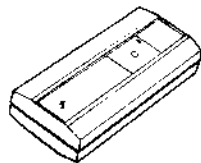
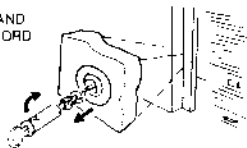

WIRED REMOTE BUTTON

For fitting in the garage or inside the house.

KEY SWITCH

For use outside the garage where transmitter inconvenient.

EXTERNAL DISENGAGEMENT DEVICE

Strongly recommended where the garage door is the only access to the garage. This allows key access from outside the garage in case of power failure.

ADDITIONAL HAND TRANSMITTERS

MORE ABOUT YOUR CONTROLL-A-DOOR

MEMORY

At the heart of your B&D Controll-A-Door is a unique Microprocessor. This stores vital information to control the door operation, such as: where the door should stop at the top and bottom and your transmitter code.

The back up memory battery will allow this information to be stored during normal power failures and will store information for about 3 weeks.

LIGHT

The light turns on whenever the Controll-A-Door is operated and turns off automatically after 2½ minutes.

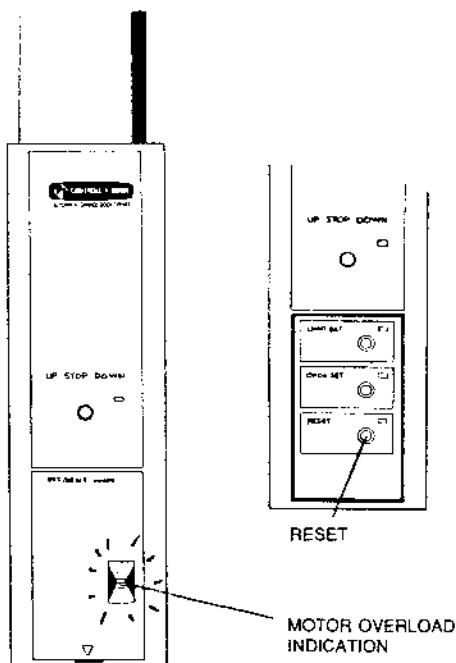

HAND TRANSMITTER

Your hand transmitter sends an ultra-high-frequency coded signal. There are over 6000 different combinations which can be set on the coding switches, so your code is very secure.

The battery life is about 1 year depending on the time the battery spent on the shelf, storage temperature and the amount of use.

REVERSING

The Controll-A-Door will reverse and go back up if the door encounters an obstruction on the way down.

AUTOMATIC LOCKING

When your Controll-A-Door is in the down position with the drive unit engaged, the door is automatically locked with the B&D's unique motor locking device. Even during a power failure security is maintained.

MOTOR OVERLOAD

The red MOTOR OVERLOAD light will flash if the effort to drive the door exceeds a preset value. If the door was going down, it will reverse. If the door was going up, it will stop for a second and then try again. If the door can't open fully it will stop and the MOTOR OVERLOAD light will continue flashing until RESET is pressed. The MOTOR OVERLOAD is set at installation to suit your garage door.

EXTENSION LEAD

For your safety, make sure that any extension lead used to connect your Controll-A-Door to the power point is a 3-core lead.

INSTALLATION INSTRUCTIONS

Read Instructions completely before starting installation.

SUITS: • MPC-2 Controll-A-Door is specifically designed for B&D Doors.

Series 1

- All Series 1 Roll-a-Doors with Nylofelt and pressed metal door drums.
- all Security Plus Roll-a-Doors.
- some earlier doors depending on door drum type, the drum position (max. 40mm in from the edge of the curtain) and the operational effort.

Series 2, 3 Wideline

- Series 2 and 3 Nylofelt doors up to 2100mm high

Requirements

Door Operation

- The door should be in reasonable operating condition and the maximum effort to move the door up or down, from stationary, should not exceed 200 Newtons (20kg force).
- For Series 1 doors manufactured before 1979 with plastic bottom rail stops, the stops will need to be replaced with a bottom rail stop (Part No. 7160).

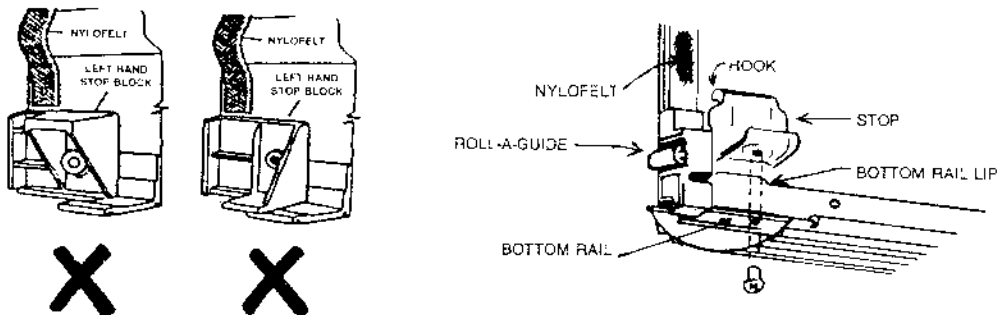

- Position** • The drive unit and wall control unit should be mounted out of the weather. Controll-A-Door is not designed for external use. Moisture may damage the unit and this is not covered by the Warranty.

Power Supply

- A 240V 3-pin properly earthed power-point is required.

Sideroom

SERIES 1, 3

NOTES

	L.H. END	R.H. END	
DIMENSION A			The L.H. end requires less sideroom due to the shape and position of the drum inside the door.
Recommended	130mm	155mm	Axle must protrude at least 70mm from edge of curtain.
Minimum	110mm	135mm	This can be further reduced by up to 10mm by use of a special fabricated bracket. Door brackets may need to be swapped over (R.H.-L.H.) to achieve sideroom requirements.

SERIES 2 WIDELINE

	Doors up to 4345 w.	Doors over 4345 w.	
DIMENSION A			On Series 2 doors there is no difference in side room between R.H. and L.H. installation.
Recommended	185mm	195mm	
Minimum	175mm	185mm	

Control-A-Door

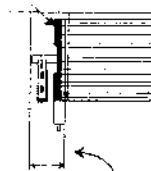

SIDEROOM A

For Roll-A-Door only. With Control-A-Door.

NOTE: These dimensions assume the drive unit will be slid onto the door axle while the door is on the ground. If the door is already installed an additional 145mm clearance is required to slide the drive unit over the axle.

General arrangement

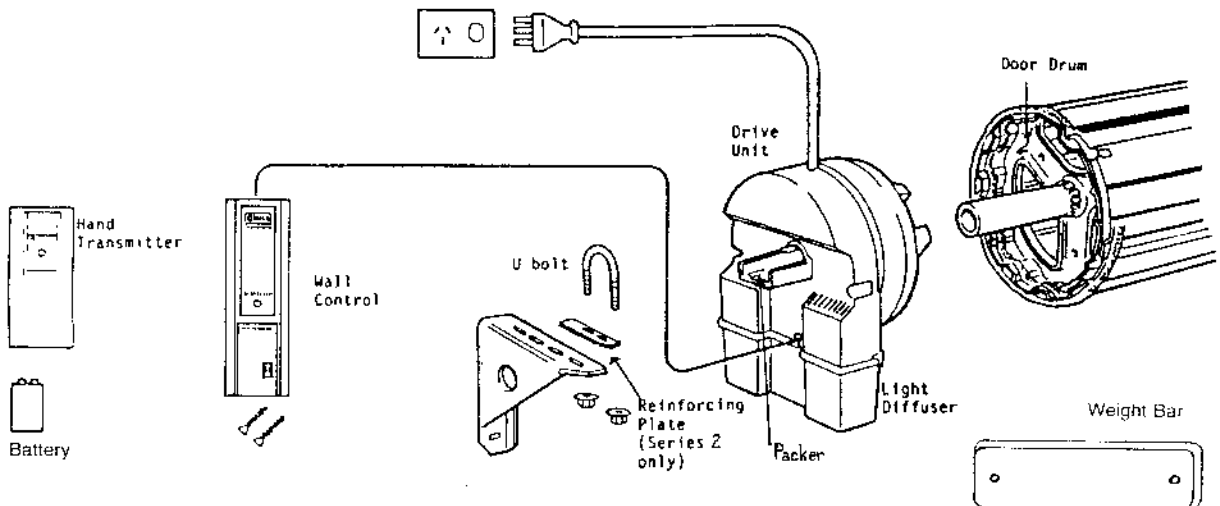

Installation procedures

Owner-installers: It is recommended that installation to Series 2 doors only be done by experienced door installers.

1. PREPARATION

- (a) Check door operation.
The door must be smooth to operate by hand. Operating force on the bottom rail should not exceed 20kg force.
Adjust the guides if they are tight or twisted.
Clean the guides if there is any oil or wax present.
- (b) Re-position the bracket if necessary. Refer to sideroom requirements (dimension B) page 6.

2. Support the door at one end, remove the U-bolt (or bolts) and saddle, and swing the door out from the guides. FOR POOR SIDEROOM INSTALLATIONS THE DOOR WILL HAVE TO BE TAKEN DOWN.

3. FIT DRIVE UNIT

- (a) Remove light diffuser and light globes.
- (b) Disengage drive unit by pulling black disengagement arm down and across, so that the ring gear can be rotated freely.
- (c) Ensure packer is in position.
- (d) Slide drive unit over door axle so that it nests into door drum.

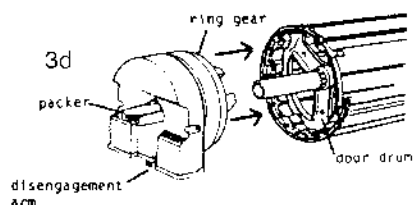
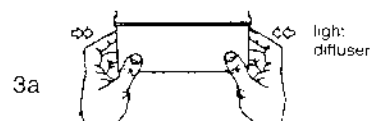

4. RE-FIT THE DOOR ONTO THE BRACKET

- (a) On Series 1 doors fit the reinforcing plates on top of the bracket at both sides.
- (b) Use the U-bolt and nuts provided.
- (c) Adjust the door position (if necessary) forward on the brackets so that door feeds smoothly into the guides. Make sure the centre of the door doesn't hit the lintel and that the curtain is not pushed forward hard into the guide (particularly Series 2, 3 – 1/2 metre below the top stops).

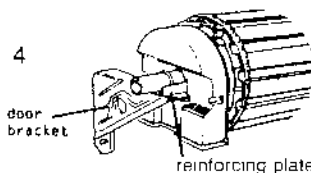

5. FIT WEIGHT BAR

- ... to all Series 1 doors,
to Series 2, 3 doors less than 3000mm wide,
and to Series 2, 3 doors installed with low headroom.
- (a) Remove the door handle.
 - (b) Fit the weight bar and refit the handle using the screws provided.

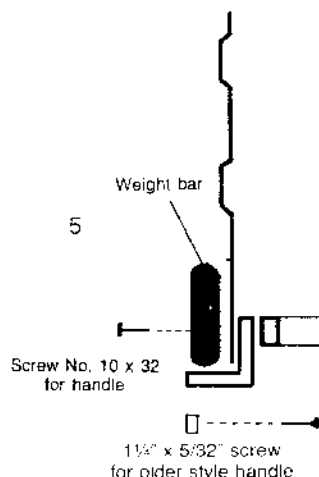

6. BALANCE THE DOOR

Re-tension the door so that the effort to close the door is the same as to open the door.

It is important, for sensitive reversing, that the door is **not** under tensioned.

- (a) With door rolled up tie two ropes around the door roll approximately 300mm from each end, as a safety precaution.
- (b) With a person at each end of the door, hold the axle firmly with a large pipe wrench (Stillson) at least 450mm long.
- (c) Loosen the "U" bolt nuts at both ends and **KEEP A FIRM GRIP ON WRENCH**.
- (d) Rotate the axle in the required direction (see diag.).
- (e) Re-tighten the "U" bolts **BEFORE** releasing pipe wrench.
- (f) Test and repeat if further adjustment is necessary.

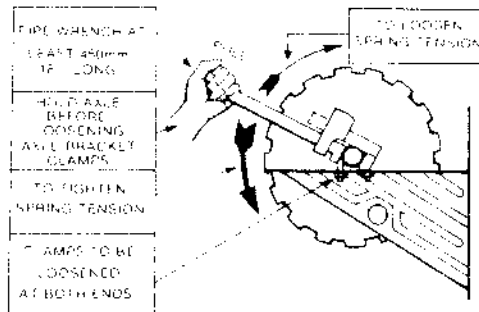

7. PIN DOOR CURTAIN

(EXTREMELY IMPORTANT PROCEDURE)

Pin door curtain to the drum to maintain security when the Controll-A-Door closes and locks.

With the door fully closed:

- (a) Mark positions to drill as shown.
- (b) Open door slightly to get access to these positions.
- (c) Drill using 3.2mm (1/8") drill.
- (d) Fix No. 10 x 32mm screws and washers to each drum. While this screw should be positioned as low as possible, make sure that it does not alter the normal curtain to guide approach.

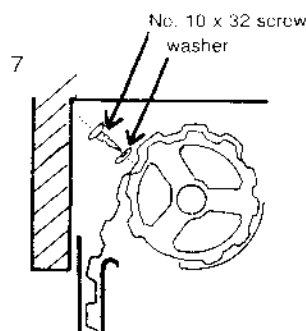

8. FIT HANDLE, GLOBES, LIGHT DIFFUSER

With door closed . . .

- (a) Refit globes.
- (b) Fit disengagement handle (wording on handle must face inwards towards garage opening).
- (c) Fit light diffuser. Push up and snap into place.
- (d) Position wall control harness along angled edge of door bracket and secure with plastic tie (provided) through bracket hole.
- (e) Position power cord and secure it so that it is well away from the moving parts of the door.

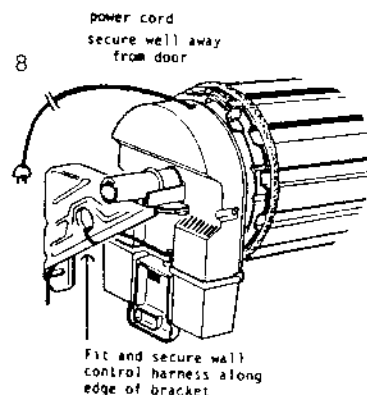

9. INSTALL WALL CONTROL UNIT

- (a) Select position protected from the weather, within 1.2m from drive unit.
- (b) Fix top screw, leaving head max. 2mm out from wall. Drill pilot hole for lower screw.
- (c) Select LEFT or RIGHT hand operation to suit the drive unit installation. Move the miniature switch (1) at the back of the wall control unit. (Left for left hand installation; right for right hand installation).
- (d) Plug in the cable for remote button or key switch if required.
- (e) Push the control cable into the slot at the back of the case.
- (f) Slip wall control slot over top screw.
- (g) Remove lower cover.
- (h) Fix bottom screw.
- (i) Bend the aerial wire so that it runs vertically up from the wall control case. (Refer page 12.3 – Aerial).

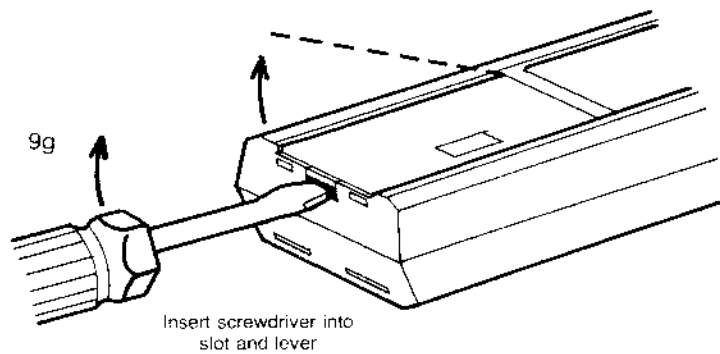
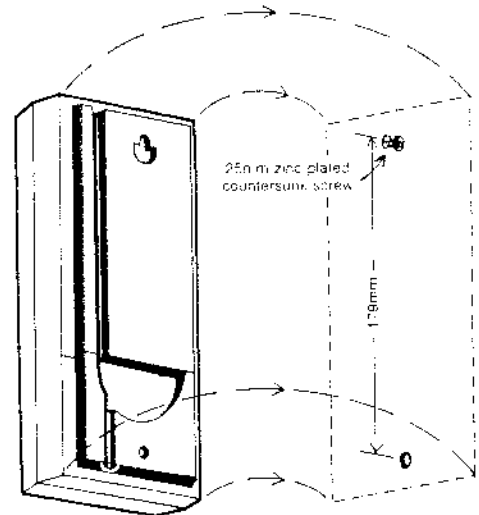

10. SET SENSITIVITY FOR REVERSING

Set switches 1 and 2 on the front lower panel according to the door type.

	SWITCH 1	SWITCH 2
1. Series 1 doors.	UP	UP (most sensitive)
2. Security Plus doors	UP	DOWN
3. Series 2, 3 doors	DOWN	UP
4. Series 2, 3 doors – heavy running	DOWN	DOWN (least sensitive)

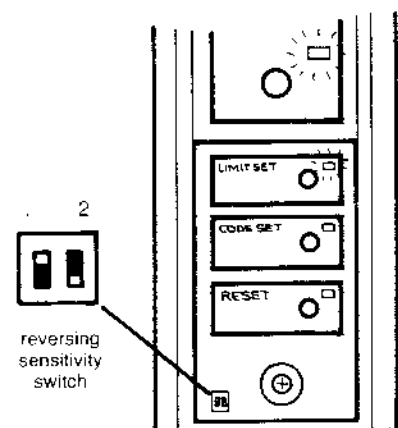

11. SET THE DOOR LIMITS MANUALLY

- (a) Disengage the drive unit and turn power on.
- (b) If LIMIT SET light is not on, press LIMIT SET. UP-STOP-DOWN will flash and LIMIT SET will come on.
- (c) Move the door down to the floor and press LIMIT SET to accept the lower limit. The LIMIT SET light will start flashing.
- (d) Move the door up to the desired OPEN position and press LIMIT SET to accept the top limit. The LIMIT SET light will go out and the UP-STOP-DOWN light will stop flashing.
- (e) Re-engage the door.

12. CHECK AND ADJUST SENSITIVITY SETTING

- (a) Press UP-STOP-DOWN and drive the door down and up. If the door stops or reverses part way then select the next less sensitive switch setting. (Refer point 10).
- (b) **S1 Doors**
Temporarily hang an extra weight bar from the door handle (or some other 3kg weight). Drive the door up. If the door stops part way then select the next less sensitive switch setting.
- (c) **S2 & S3 Doors**
Select setting No. 2 if the door runs up and down without stopping or reversing when setting No.1 is temporarily used.
Select setting No. 3 if the door runs up and down okay on setting No.2, but not on setting No.1.
Select setting No. 4 if the door won't run smoothly on setting No.3.

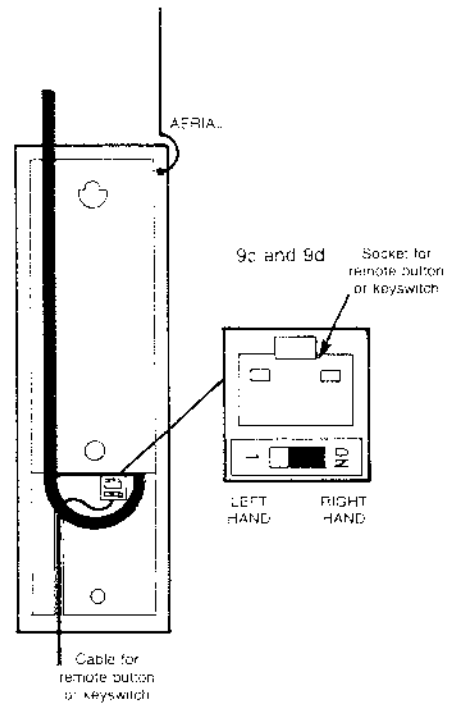

13. SET LIMITS AGAIN to test Automatic Limit Setting.

- (a) Press LIMIT SET to activate Limit Setting mode.
- (b) Press UP-STOP-DOWN.
The door will go down and close hard on the floor. (if the door is already at the floor it will go up then down.) The bottom limit will be accepted automatically. The Limit light will start flashing.
- (c) Press UP-STOP-DOWN.
Allow door to open fully and hit the top stops. The Limit light will go out and UP-STOP-DOWN will stop flashing. Both limits of door travel are now set. In normal operation the door stops just before hitting the floor or the top stops.

14. SET THE RADIO CODE

- (a) Fit the battery correctly to the terminal in hand transmitter.
- (b) Set transmitter switch combination.
- (c) Press Code Set. (The Code Set light will come on).
- (d) Press the hand transmitter for 2 seconds. (Code Set light goes out and UP-STOP-DOWN light comes on when the code has been accepted.)

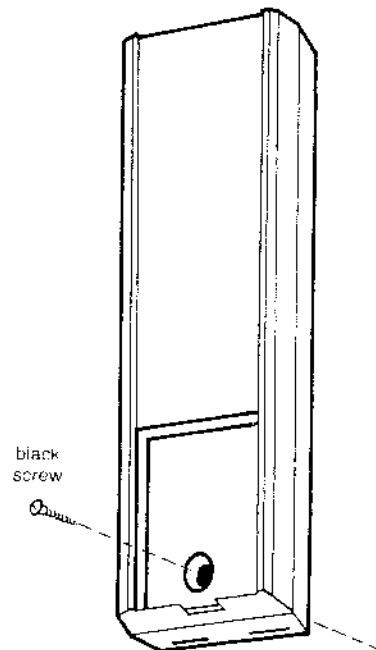

15. REPLACE LOWER COVER ON WALL CONTROL.

16. STICK THE RED SAFETY LABEL to the wall next to the wall control unit.
17. INSTALL KEY SWITCH, REMOTE BUTTON OR EXTERNAL ACCESS DEVICE if required.
18. ATTACH A CORD TO THE DISENGAGEMENT HANDLE if it is required.
19. Tear off the Warranty Card from the packaging sleeve. The owner is to keep it in safe place with the Owner's Handbook.

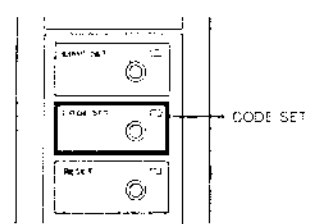
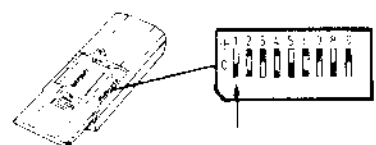

20. HOW TO SET (OR CHANGE) YOUR CODE

Your personal 'code' can easily be changed as follows:

- (a) Select your code on the hand transmitter. Set switches 1 to 9 to any combination of '-', '0' and '+' positions. Note: Switch No. 1 inactive for single channel transmitters.
- (b) Remove the lower cover from the wall control.
- (c) Press CODE SET. The red Code Set light will come on.
- (d) Press HAND TRANSMITTER for 2 seconds. The Code Set light will go out when the Controll-A-Door has 'learnt' your code and the green UP.STOP.DOWN light will come on.

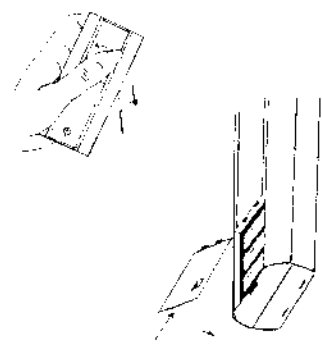

Replace the lower cover on the wall control unit. Guide the 2 lugs into position and snap it closed.

The Controll-A-Door is now ready to be operated by your hand transmitter.

Simply press the hand transmitter for 1/2 second to operate the door.

Make sure to check that:

- reinforcing plates are fitted on top of the door brackets at both sides (for a Series 1 door).
- door curtain is pinned to the drum.
- transmitter code has been changed from the original preset code.

NOTES ABOUT MPC-2

1. Testing Controll-A-Door on the floor.

When testing a Controll-A-Door drive unit on the floor, and the drive unit is 'seeking the floor', the best way to stop the drive unit is to pull the 'disengagement' arm. The drive unit 'thinks' the door has hit the floor and it will stop and set its bottom limit.

2. **Left hand and right hand Installations.**

The switch at the back of the wall control is all that needs to be changed to suit a right hand installation. Ignore the half-hidden switch (No. 2).

3. **Aerial.**

The aerial should run vertically above the wall control case. The aerial should not be against a sheet metal surface. If so, move the wall control to one side or space it out from the sheet metal by at least 20mm with, for example, a wooden block.

4. **Sensitivity Switches.**

The 2 slide switches at the bottom left corner of the wall control unit control the overload sensitivity of the Control-A-Door in both directions.

If an 'overload' occurs while the door is going up, the Control-A-Door stops for a second and then starts again. If another 'overload' occurs while the door is still going up, the Control-A-Door will stop and the MOTOR RESET light will flash.

5. **Limit Setting Sequence.**

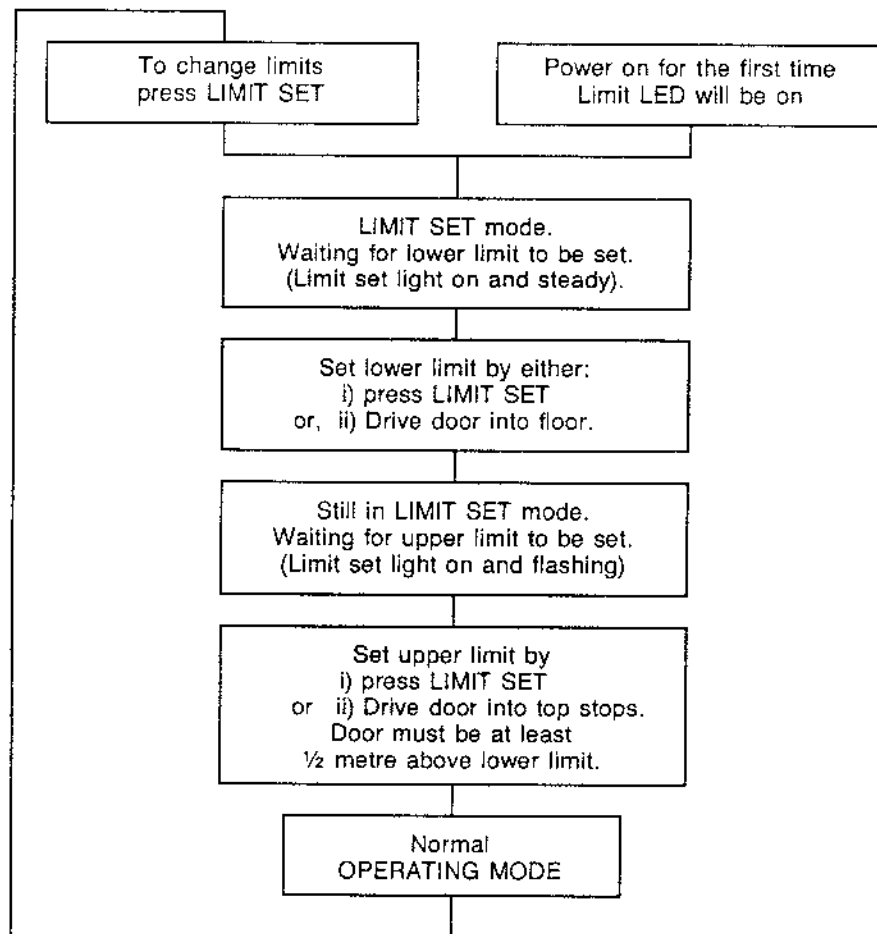

6. After the power has been off

When the power comes back on, or is switched on at the power point, then:

If the Limit Setting procedure has not been finished the MPC-2 Controll-A-Door will be in Limit Set mode at the start of the limit setting sequence.

If the power has been off for more than about 3 weeks and the memory is lost, the MPC-2 Controll-A-Door will be in the LIMIT SET mode and the limits and code will need to be set again.

If the memory has not been lost, and the Controll-A-Door had been in normal operating mode:

The Controll-A-Door will be in 'Warm-start' mode.

When the UP-STOP-DOWN button is pressed the door will go down and close hard against the floor (to confirm its lower limit).

If the door is already closed, the door will try to go down, then go up 150mm, down to the floor and then open.

7. Code Set

The code can only be set after the limits have been set.

8. Reset

The reset light flashes if:

i) the Controll-A-Door has been run while disengaged.

or, ii) the motor load has exceeded the normal maximum load pre-set by the sensitivity switches.

Pressing the RESET button returns the Controll-A-Door:

to the 'operating mode'

or, to the LIMIT SET mode, if the limits had not been set.

9. Transmitter

The transmitter supplied with MPC-2 Controll-A-Door operates at 318 MHz.

10. Guides

The guides may be cleaned but lubricant sprays, polish, talc, etc. should never be put into the guides. These products are absorbed in the nylofelt and, in turn, dirt accumulates and adheres to the nylofelt. This then causes the friction in the guides to **increase**.

DO NOT USE WD40, CRC, CAR POLISH, FURNITURE POLISH OR TALC IN THE GUIDES.

TROUBLE SHOOTING during INSTALLATION

Problems	Possible Cause	Solutions
1. No lights on wall control.	Control harness not plugged in fully.	Push the plug fully home into socket on power board in drive unit.
2. Top limit can't be set manually.	(a) Left hand/right hand switch is set for opposite hand. or, (b) Bottom limit may have been accidentally set near top of door travel.	Change left hand/right hand switch and then . . . Turn power OFF for a moment, then ON again. Set bottom limit first and then the top limit.
3. Door reverses on its own.	(a) Door balloons slightly as it starts down. (b) Controll-A-Door is too sensitive. or, (c) Door is over tensioned. (Harder to close manually). (d) Tight spot in guides.	See 5. Change sensitivity switches to next less sensitive position. Reduce door tension. Adjust the guides
4. Door stops on the way up.	(a) Is the reversing very coarse?	(i) Yes. Increase the door tension so the door effort is equal to open and close the door. (ii) No. Change sensitivity switches to next less sensitive position.
5. Door balloons.	No weight bar on Series 1 door or, S2, S3 installed with low headroom. or, narrow S2, S3 door.	} Fit weight bar.
	Curtain is jamming between door roll and guide, (particularly S2, S3 when door is ½ metre down).	Move door away from lintel.
	Guide block catching in the guide.	(i) Adjust guide or, (ii) File off burrs or, (iii) Clean dirt and corrosion out of guides. (iv) Fit guide roller kit if old door (See page 5).
	Guides or Nylofelt dirty with accumulated grease, oil, talc or wax (from polishes)	Clean (If and only if door still balloons, add an extra weight bar. Then check door tension).

TROUBLE SHOOTING during INSTALLATION

Problems	Possible Cause	Solutions
6. Door closes too tight.	Curtain not pinned to the drum or pinned too far round the drum.	Pin the curtain. Then set the limits again.
7. Door hits top stops.	(i) Curtain not pinned properly. or, (ii) Door is over tensioned.	Pin the curtain and set the limits again. Re-tension the door and/or set the top limit manually.
8. Poor radio range.	Wall control unit is against sheet metal.	Check that aerial is vertical and not broken. Keep the aerial away from the sheet metal. Fit a wood block between.

WARRANTY

- A. The Manufacturer, B&D Doors (NSW), a member of the Clyde Group ("B&D") of 34-36 Mangrove Street, Hereford, subject to the terms set out here, hereby warrants to the original retail purchaser (the Buyer) that the B&D Control-A-Door ("the Unit") including every major component part thereof will be free from defects in materials and workmanship in normal use, service and operation:
- (i) for a period of two (2) years:
 - (a) where the residential unit is installed in and for the purposes of domestic or residential applications; and
 - (b) where the industrial unit is installed in and for the purposes of industrial or commercial applications; or
 - (ii) for a period of three (3) months:
 - (a) where the residential unit is installed in and for the purposes of industrial or commercial applications; and
 - (b) where the industrial unit is installed in and for the purposes of domestic or residential applications in any 3 months.
- Such warranty periods shall run from the date of delivery of the Unit where delivery is effected by B&D or one of its Authorised Distributors listed in the Owner's Handbook supplied with the Unit or from the date of purchase in any other case.
- B. (i) Notwithstanding anything herein where the Unit has been installed by B&D or an Authorised Distributor, the period of warranty provided for in paragraph A above shall run from the date of such installation and the Buyer shall be entitled to free service by B&D or its Authorised Distributor to remedy any defects covered by this Warranty. The Buyer will pay for any service call made by B&D or its Authorised Distributor when in the opinion of B&D these calls are made for the purpose of adjustment which is described in the Owner's Handbook.
- (ii) Where the Unit has not been installed by B&D or an Authorised Distributor, B&D, in addition to any warranty which may be offered by the party who installed the Unit, will within a reasonable period of time after notification of the defect by the Buyer and on return of the defective part or Unit to B&D (or at its option, remedy any defective part or Unit covered by this Warranty) without charge provided that all costs of disconnection, re-installation and freight shall be borne by the buyer.
- C. **Notification and Proof to be given by the Buyer**
In the event of any defect in the Unit arising, the Buyer must notify directly either B&D at the above address or an Authorised Distributor and must establish to the reasonable satisfaction of B&D or such Distributor the date of purchase or installation (as the case may be) by way of invoice or installer stamp on the Warranty Form contained in the Owner's Handbook.
- D. **Future Modifications**
B&D may make such modifications to any existing or future models of the Unit as it may deem necessary without incurring any obligation to incorporate such modifications in Units previously sold or to which this Warranty may relate.
- E. **General**
Subject to paragraph F below, the obligations of B&D or an Authorised Distributor under this Warranty are limited to those contained herein and this Warranty is the only warranty made by a person authorised by B&D in writing and exclusively and expressly in lieu of all other warranties permitted to be excluded by law (whether those warranties are express, implied, under the common law or by statute) and the terms of this Warranty may not be modified by any person, firm or corporation other than B&D.
- F. **Exclusions**
Notwithstanding the terms herein but subject to paragraph H herein, this Warranty shall not apply and B&D or its Authorised Distributors will be relieved of all obligations, responsibilities and liabilities (direct or consequential) in the event that defects in or malfunctions of the Unit are directly or indirectly in the opinion of B&D due to or result from:
(i) lack of proper maintenance or care of the Unit;
(ii) improper or unreasonable use;
(iii) faulty installation or adjustment of the Unit or door to which the Unit is connected where such installation or adjustment is not carried out by B&D or one of its Authorised Distributors;
(iv) failure to observe any instructions or directions provided with the Unit or given to the Buyer by the installer;
(v) modifications or repairs made or attempted to be made by any person not Authorised by B&D;
(vi) faulty electrical wiring of structures to which the Unit is fitted; or
(vii) radio producing or other electromagnetic interference.
Notwithstanding the terms herein but subject to paragraph H, this Warranty:
(a) does not apply when the Unit is supplied with or fitted to any door or other closing device which is not manufactured or sold as an authorised B&D door or, where it is an authorised B&D door, is not of the type or condition specified as suitable for installation of the Unit in the Owner's Handbook Annex, Installer's Instructions at page 3; and
(b) does not cover and shall not relate to batteries or gaskets supplied with the Unit and B&D or its Authorised Distributors shall not be liable for any defect, malfunction or failure of such items.
- G. This warranty constituted by paragraphs A to F above shall apply only to purchasers who are Australian residents. In the case of original retail sales to persons other than Australian residents, B&D, subject to paragraph H below, limits its liability absolutely to the extent permitted by law.
- H. **Statutory Warranties**
IT IS EXPRESSLY PROVIDED THAT THIS WARRANTY OR ANY TERMS AND CONDITIONS OF IT OR OTHER STATEMENT CONTAINED IN THIS DOCUMENT, THE OWNER'S HANDBOOK OR OTHER LITERATURE GIVEN TO THE BUYER SHALL NOT BE READ OR APPLIED SO AS TO PURPORT TO EXCLUDE, RESTRICT OR MODIFY OR HAVE THE EFFECT OF EXCLUDING, RESTRICTING OR MODIFYING THE APPLICATION IN RELATION TO THE SUPPLY OF THE UNIT OR A.U. OR ANY OF THE PROVISIONS OF DIVISIONS 2 AND 24 OR PART V OF THE TRADE PRACTICES ACT, 1974 (THE ACT) AS AMENDED OR THE EXERCISE OF A RIGHT CONFERRED BY SUCH PROVISIONS OR ANY OTHER CONDITIONS OR WARRANTIES IMPLIED BY AND RELEVANT STATE ACT OR TERRITORIAL ORDINANCE OR BY THE GENERAL LAW AND WHICH BY LAW CANNOT BE EXCLUDED, RESTRICTED OR MODIFIED PROVIDED THAT TO THE EXTENT THAT THE ACT PERMITS B&D TO LIMIT ITS LIABILITY FOR A BREACH OF A CONDITION OR WARRANTY IMPLIED BY THE ACT, THEN B&D'S LIABILITY FOR SUCH BREACH SHALL BE LIMITED TO THE PAYMENT OF THE COST OF REPLACING THE GOODS OR ACQUIRING EQUIVALENT GOODS OR OF REPAIRING THE GOODS.
- I. **RE-SUPPLIER INDEMNITY**
This Warranty shall not apply to any person or body other than the original retail purchaser of any Unit from B&D or its Authorised Distributor. Except to the extent covered herein, B&D or its Authorised Distributors shall have no liability (including liability in negligence, to any person or body for any loss or damage consequential or otherwise, howsoever suffered or incurred, by any such person or body in relation to the Units or the services provided in respect of the Units and without limiting the generality thereof, in particular any loss or damage consequential or otherwise, howsoever suffered or incurred by any such person or body, caused by or resulting directly or indirectly from the supply of services or from any failure, breakdown, defect or deficiency of whatsoever nature or kind in the Units.

FILL THIS IN NOW FOR YOUR RECORD

Name:

Address:

Purchased from:

Installed by:

Installed on (date):

(Onus on owner for proof of purchase date)

PATENTS AND REGISTERED DESIGNS APPLIED FOR: Driving arrangement, Drive unit, Disengagement mechanisms, Electronic programme, limit setting, code setting, solenoid locking, Ring gear, Drive Unit cover, Lamp housing, Chassis, Hand transmitter.